

# PowerScan™ PBT9501

## Industrial Cordless Handheld Area Imager Bar Code Reader



**BSR idware GmbH**  
Jakob-Haringer-Str.3  
A-5020 Salzburg  
<https://www.bsr.at>  
[sales@bsr.at](mailto:sales@bsr.at)



**Quick Reference Guide**

**Datalogic USA Inc.**

959 Terry Street  
Eugene, OR 97402  
U.S.A.  
Telephone: (541) 683-5700  
Fax: (541) 345-7140

**©2013-2019 Datalogic S.p.A. and/or its affiliates**

An Unpublished Work - All rights reserved. No part of the contents of this documentation or the procedures described therein may be reproduced or transmitted in any form or by any means without prior written permission of Datalogic USA Inc. or its subsidiaries or affiliates ('Datalogic' or 'Datalogic USA').

Owners of Datalogic products are hereby granted a non-exclusive, revocable license to reproduce and transmit this documentation for the purchaser's own internal business purposes. Purchaser shall not remove or alter any proprietary notices, including copyright notices, contained in this documentation and shall ensure that all notices appear on any reproductions of the documentation.

Should future revisions of this manual be published, you can acquire printed versions by contacting your Datalogic representative. Electronic versions may either be downloadable from the Datalogic website ([www.datalogic.com](http://www.datalogic.com)) or provided on appropriate media. If you visit our website and would like to make comments or suggestions about this or other Datalogic publications, please let us know via the "Contact Datalogic" page.

**Disclaimer**

Datalogic has taken reasonable measures to provide information in this manual that is complete and accurate, however, Datalogic reserves the right to change any specification at any time without prior notice. Datalogic and the Datalogic logo are registered trademarks of Datalogic S.p.A. in many countries, including the U.S. and the E.U. PowerScan is a trademark of Datalogic S.p.A. and/or its affiliates, registered in many countries, including the U.S. and the E.U. The Bluetooth word mark and logos are owned by Bluetooth SIG, Inc. and any use of such marks by Datalogic Group companies is under license. All other trademarks and brands are property of their respective owners.

**Patents**

See [www.patents.datalogic.com](http://www.patents.datalogic.com) for patent list.

**See the Regulatory Addendum included with your product for additional regulatory, safety and legal information.**



# Table of Contents

END USER SOFTWARE LICENSE AGREEMENT (EULA) .....	iii
Software Product Policy .....	vii
Description .....	1
General Features .....	1
Using the PowerScan™ PBT9501 .....	2
Installing the Battery Pack .....	3
Charging the Batteries .....	6
Changing the Batteries .....	6
Programming .....	7
Using Programming Bar Codes .....	7
Configure Other Settings .....	7
Resetting Product Defaults .....	7
Set Date and Time .....	8
Linking the Reader .....	9
Link Datalogic RF Devices to Base.....	9
Linking to a Bluetooth Adapter in Serial Port Profile (Slave) Mode .....	9
Linking to a Bluetooth Adapter in HID mode.....	10
Variable PIN Code .....	11
HID Country Mode .....	12
HID Caps Lock State .....	16
HID Alt Mode .....	17
Power Off .....	17
Operating Mode .....	18
Scan Mode .....	18
Motion Aiming Control .....	19
Pick Mode .....	20
Multiple Label Reading .....	20
Technical Specifications .....	21
LED and Beeper Indications .....	25
Error Codes .....	27
Cleaning .....	28
Datalogic Limited Factory Warranty .....	29
Ergonomic Recommendations .....	31
Support Through the Website .....	32
Hex-Numeric Keypad .....	33
For HID Variable Pin Code only.....	35

---

# NOTES



**DATALOGIC IP TECH S.R.L.**  
**END USER SOFTWARE LICENSE AGREEMENT (EULA)**  
**FOR THE POWERSCAN™ 9501**

Notice to End User: There are two types of software covered by this END USER LICENSE AGREEMENT ("EULA"): (1) The Datalogic Product you have acquired contains embedded software ("Embedded Software") which is integral to the Product's operation; and (2) Optional Application Software provided to you on an optional basis ("Application Software"). Embedded Software and Application Software are collectively referred to as "Software" and are subject to the terms and conditions contained in this EULA. Software is provided only for use with, and for authorized end users of, the Datalogic PowerScan™ 95XX ("Product"). Portions of the Embedded Software include or operate with Open Source software or libraries ("Open Source"). Use of Open Source is subject to the Open Source licenses available at the following website: <http://www.datalogic.com/oss>.

This EULA (End User Software License Agreement) ("EULA" or "Agreement") is a legally binding agreement governing the licensing of the Software and Documentation by Datalogic IP Tech S.r.l. and its subsidiaries and affiliates ("Datalogic") to the entity or person who has purchased or otherwise acquired a Datalogic Product ("End User"). For purposes of this Agreement, any software that is not Embedded Software or Application Software is software associated with a separate end-user license agreement is licensed to you under the terms of that license agreement. Datalogic and End User hereby agree as follows:

## **1. Definitions**

- 1.1 "Affiliate" means a business entity currently existing or later acquired that is controlled by, or is under common control with Datalogic S.p.A.
- 1.2 "Documentation" means materials such as user's guides, program reference guides, quick reference guides, manuals, or similar materials associated with or related to the Datalogic Product, whether in printed, "online", or other form.
- 1.3 "Proprietary Information" means: (a) source code, object code, software, documentation, and any related internal design, system design, data base design, algorithms, technology, technical data or information, implementation techniques, and trade secrets related to the Software, (b) any other trade secrets marked appropriately or identified as proprietary or confidential, and (c) any information that End User, under the circumstances, should recognize as confidential. Proprietary Information does not include any information that the receiving party can establish was (1) in the public domain, (2) already in the receiving party's possession or rightfully known prior to receipt, (3) rightfully learned from a third party not in violation of any other's proprietary rights, or (4) independently developed without access to Proprietary Information.
- 1.4 "Datalogic Product" means the Datalogic Powerscan™ series scanner product, including all embedded Software in and all Documentation related to such product, which has been purchased or otherwise acquired by End User, whether obtained directly or indirectly from Datalogic.
- 1.5 "Software" means any software or computer programs of Datalogic or its third party licensors in machine readable form which is embedded in the Datalogic Product, whether obtained directly or indirectly from Datalogic, including any replacement, update, upgrade, enhancement or modification.

## **2. Scope Of License Granted**

- 2.1 Datalogic grants to End User a personal non-exclusive, non-transferable, perpetual license to use the Software, solely on the Datalogic Product in which it is embedded ("designated Datalogic

---

Product"), in machine-readable form only, solely for End User's internal business purposes. This Agreement does not convey ownership of the Software to End User. Title to the Software shall be and remain with Datalogic or the third party from whom Datalogic has obtained a licensed right. As used in this Agreement, the term "purchase" or its equivalents when applied to the Software shall mean "acquire under license." End User is not entitled to receipt or use of the source code to any Software.

- 2.2 End User shall not copy, modify, decompile, disassemble, reverse engineer, or otherwise reproduce or remanufacture the Software, whether modified or unmodified, nor sell, assign, sublicense, distribute, lend, rent, give, or otherwise transfer the Software to any other person or organization, for purposes other than as expressly provided in this Agreement, without Datalogic's prior written consent.

### **3. Transfers, Support**

- 3.1 Any copying, installing, reproduction, remanufacture, reverse engineering, electronic transfer, or other use of the Software on other than the designated Datalogic Product will be a material breach of this Agreement. However, Datalogic may elect not to terminate this Agreement or the granted licenses, but instead may elect to notify End User that End User is deemed to have ordered and accepted a license for each breaching use. End User shall pay Datalogic the applicable list price for such licenses as of the date of such breach.
- 3.2 End User shall not sell, assign, sublicense, distribute, lend, rent, give, or otherwise transfer the Datalogic Product to any third party unless such third party agrees with Datalogic in writing to be bound by the terms and conditions of this Agreement. Any such transfer of the Datalogic Product absent such agreement shall be null and void.
- 3.3 End User may obtain support for Software from Datalogic at Datalogic's standard support fees and under Datalogic's standard support terms and conditions in effect at the time the support is requested.

### **4. Intellectual Property**

End User acknowledges that the Software comprises valuable trade secrets of Datalogic or Datalogic's third party licensors and that the Software is protected by United States copyright law and trade secret law, and by all applicable international intellectual property laws and treaty provisions. The license set forth in this Agreement does not transfer to End User any ownership of Datalogic's or its third party licensors' copyrights, patents, trademarks, service marks, trade secrets, or other intellectual property rights and End User shall have no right to commence any legal actions to obtain such rights. End User shall not remove, modify, or take any other action that would obscure any copyright, trademark, patent marking, or other intellectual property notices contained in or on the Datalogic Product.

### **5. Proprietary Information**

- 5.1 End User acknowledges that Proprietary Information is the confidential, proprietary, and trade secret property of Datalogic and Datalogic's third party licensors and End User acquires no right or interest in any Proprietary Information.
- 5.2 End User shall not disclose, provide, or otherwise make available the Proprietary Information of Datalogic or its third party licensors to any person other than End User's authorized employees or agents who are under confidentiality agreement, and End User shall not use the Proprietary Information other than in conjunction with use of the Datalogic Product exclusively for End User's internal business purposes. End User shall take steps to protect the Proprietary Information no less securely than if it were End User's own

---

intellectual property.

- 5.3 The provisions of this Proprietary Information Section shall survive and continue for five (5) years after the termination of this Agreement.

## **6. Limited Warranty**

- 6.1 Datalogic warrants that, under normal use and operation, the Datalogic Product will conform substantially to the applicable Documentation for the period specified in the Documentation. During this period, for all reproducible nonconformities for which Datalogic has been given written notice, Datalogic will use commercially reasonable efforts to remedy nonconformities verified by Datalogic. End User agrees to supply Datalogic with all reasonably requested information and assistance necessary to help Datalogic in remedying such nonconformities. For all defects reported to Datalogic within the warranty period, Datalogic's liability is limited to providing End User with one copy of corrections or responding to End User's problem reports according to Datalogic's standard assistance practices. Datalogic does not warrant that the product will meet End User's requirements or that use of the product will be uninterrupted or error free, or that Datalogic's remedial efforts will correct any nonconformance. This limited warranty does not cover any product that have been subjected to damage or abuse, whether intentionally, accidentally, or by neglect, or to unauthorized repair or unauthorized installation, and shall be void if End User modifies the product, uses the product in any manner other than as established in the Documentation, or if End User breaches any of the provisions of this Agreement.
- 6.2 EXCEPT AS PROVIDED IN THIS AGREEMENT, THE DATALOGIC PRODUCT IS PROVIDED "AS IS" AND DATALOGIC MAKES NO WARRANTIES OF ANY KIND, EXPRESS OR IMPLIED, WRITTEN OR ORAL, WITH RESPECT TO THE PRODUCT, AND SPECIFICALLY DISCLAIMS THE IMPLIED WARRANTIES OF MERCHANTABILITY AND FITNESS FOR A PARTICULAR PURPOSE.

## **7. Infringement**

To the maximum extent permitted by law, End User agrees to defend, indemnify and hold harmless Datalogic, its affiliates and their respective directors, officers, employees and agents from and against any and all claims, actions, suits or proceedings, as well as any and all losses, liabilities, damages, costs and expenses (including reasonable attorney's fees) arising out of or accruing from (a) the End User's use of Software, (b) any application the End User develops on the Software that infringes any Intellectual Property Rights of any person or defames any person or violates their rights of publicity or privacy, and (c) any non-compliance by the End User of this Agreement.

## **8. Limitation Of Liability**

DATALOGIC SHALL NOT BE LIABLE FOR ANY CLAIMS AGAINST END USER BY ANY OTHER PARTY. IN NO EVENT SHALL DATALOGIC'S LIABILITY FOR DAMAGES, IF ANY, WHETHER BASED UPON CONTRACT, TORT (INCLUDING NEGLIGENCE), PRODUCT LIABILITY, STRICT LIABILITY, WARRANTY, OR ANY OTHER BASIS, EXCEED THE PRICE OR FEE PAID BY END USER FOR THE DATALOGIC PRODUCT. UNDER NO CIRCUMSTANCES SHALL DATALOGIC BE LIABLE TO END USER OR ANY THIRD PARTY FOR LOST PROFITS, LOST DATA, INTERRUPTION OF BUSINESS OR SERVICE, OR FOR ANY OTHER SPECIAL, CONSEQUENTIAL, CONTINGENT, INDIRECT, INCIDENTAL, PUNITIVE, EXEMPLARY, OR OTHER SIMILAR DAMAGES, EVEN IF DATALOGIC HAS BEEN ADVISED OF THE POSSIBILITY OF SUCH DAMAGES.

## **9. Government Restricted Rights; International Use**

- 9.1 Use, duplication, or disclosure of the Software by the U.S. Government is subject to the restrictions for computer software devel-

---

oped at private expense as set forth in the U.S. Federal Acquisition Regulations at FAR 52.227-14(g), or 52.227-19 or in the Rights in Technical Data and Computer Software clause at DFARS 252.227-7013(c)(1)(ii), whichever is applicable.

- 9.2 If End User is using the Datalogic Product outside of the United States, End User must comply with the applicable local laws of the country in which the Datalogic Product is used, with U.S. export control laws, and with the English language version of this Agreement. The provisions of the "United Nations Convention on International Sale of Goods" shall not apply to this Agreement.

## **10. Termination**

- 10.1 Either party may terminate this Agreement or any license granted under this Agreement at any time upon written notice if the other party breaches any provision of this Agreement.
- 10.2 Upon termination of this Agreement, End User immediately shall cease using any non-embedded software and shall return to Datalogic or destroy all non-embedded software covered by this Agreement, and shall furnish Datalogic with a certificate of compliance with this provision signed by an officer or authorized representative of End User. For embedded software, End User agrees to sign a waiver prepared by Datalogic concerning further use of the embedded Software. End User's resumed or continued use of the embedded Software after termination shall constitute End User's agreement to be bound by the terms and conditions of this Agreement for such use.

## **11. General Provisions**

- 11.1 Entire Agreement; Amendment. This document contains the entire agreement between the parties relating to the licensing of the Software and supersedes all prior or contemporaneous agreements, written or oral, between the parties concerning the licensing of the Software. This Agreement may not be changed, amended, or modified except by written document signed by Datalogic.
- 11.2 Notice. All notices required or authorized under this Agreement shall be given in writing, and shall be effective when received, with evidence of receipt. Notices to Datalogic shall be sent to the attention of Datalogic IP Tech S.r.l., Legal & IP Department, Via San Vitalino 13, 40012 Calderara di Reno (Bologna), Italy or such other address as may be specified by Datalogic in writing.
- 11.3 Waiver. A party's failure to enforce any of the terms and conditions of this Agreement shall not prevent the party's later enforcement of such terms and conditions.
- 11.4 Governing Law; Venue: Both parties agree to the application of the laws of the country in which End User obtained the license to govern, interpret, and enforce all of End User's and Datalogic's respective rights, duties, and obligations arising from, or relating in any manner to, the subject matter of this Agreement, without regard to conflict of law principles. The United Nations Convention on Contracts for the International Sale of Goods does not apply.

All rights, duties, and obligations are subject to the courts of the country in which End User obtained the license. For licenses granted by Licensee who operates in the countries specified below, the following terms applies.

For Americas.

This Agreement is governed by the laws of the State of Oregon. This Agreement and the rights of the parties hereunder shall be governed by and construed in accordance with the laws of the State of Oregon U.S.A, without regard to the rules governing conflicts of law. The state or federal courts of the State of Oregon located in either Multnomah or Lane counties shall have exclusive jurisdiction over all matters regarding this Agreement, except that

Datalogic shall have the right, at its absolute discretion, to initiate proceedings in the courts of any other state, country, or territory in which End User resides, or in which any of End User's assets are located. In the event an action is brought to enforce the terms and conditions of this Agreement, the prevailing party shall be entitled to reasonable attorneys' fees, both at trial and on appeal.

For Europe, Middle East and Africa

This Agreement is governed by the laws of Italy. This Agreement and the rights of the parties hereunder shall be governed by and construed in accordance with the laws of Italy, without regard to the rules governing conflicts of law. Italian Court of Bologna shall have exclusive jurisdiction over all matters regarding this Agreement, except that Datalogic shall have the right, at its absolute discretion, to initiate proceedings in the courts of any other state, country, or territory in which End User resides, or in which any of End User's assets are located. In the event an action is brought to enforce the terms and conditions of this Agreement, the prevailing party shall be entitled to reasonable attorneys' fees, both at trial and on appeal.

For Asia- Pacific Countries

This Agreement is governed by the laws of the State of Hong Kong. This Agreement and the rights of the parties hereunder shall be governed by and construed in accordance with the laws of the State of Hong Kong without regard to the rules governing conflicts of law. The Court of Hong Kong shall have exclusive jurisdiction over all matters regarding this Agreement, except that Datalogic shall have the right, at its absolute discretion, to initiate proceedings in the courts of any other state, country, or territory in which End User resides, or in which any of End User's assets are located. In the event an action is brought to enforce the terms and conditions of this Agreement, the prevailing party shall be entitled to reasonable attorneys' fees, both at trial and on appeal.

11.5 Attorneys' Fees. In the event an action is brought to enforce the terms and conditions of this Agreement, the prevailing party shall be entitled to reasonable attorneys' fees, both at trial and on appeal.

**- END -**

## **Software Product Policy**

Datalogic reserves the right to ship its products with the latest version of software/firmware available. This provides our customers with the very latest in Datalogic software technology.

The only exception to this policy is when the buyer has a signed contract with Datalogic that clearly defines the terms and conditions for making software/firmware changes in products shipped to the buyer.

To arrange for a Software Maintenance and Support Agreement please contact your Datalogic sales person.

# NOTES



# PowerScan™ PBT9501

## Description

The PowerScan™ PBT9501 reader is a feature-rich and rugged area imager. It is offered in several different models to better fit the different needs of each customer.

The table below shows the unique features of each model:

Model P/N	Optical feature
PBT9501-XX	Standard optic, standard and low density codes
PBT9501-HPXX	Autofocus optic, High, standard and low density codes, wide angle
PBT9501-DPMXX	High Density optic, high and medium density codes, DPM (laser, ink jet and dot peen)

## General Features

Omni-directional Operating	To read a symbol or capture an image, you simply aim the reader and pull the trigger. Since the PowerScan™ PBT9501 is a powerful omni-directional reader, the orientation of the symbol is not important.
Decoding	Thanks to powerful algorithms, PowerScan™ PBT9501 reader reliably decodes all major 1D (linear) barcodes, 2D stacked codes (such as PDF417), 2D matrix symbols (such as DataMatrix), postal codes (such as POSTNET, PLANET). The data stream — acquired from decoding a symbol — is rapidly sent to the host. The reader is immediately available to read another symbol.
Formatting and Concatenating	The string of a decoded code may be processed according to either a simple or advanced data formatting and be concatenated.
Imaging	PowerScan™ PBT9501 reader can also function as a camera by capturing entire images (valid only for RS-232 and USB-COM on the Base Station).



Autoscanning	An autoscan command causes the reader to scan continuously and to monitor the central zone of its reading area.
Flash Memory	Flash technology allows you to upgrade the PowerScan™ PBT9501 reader as new symbologies are supported or as new features become available.
USA Driver License Parsing	The reader can be set up to select and output a subset of data elements from USA Driver License PDF417 barcodes. This feature can be enabled using either Datalogic Aladdin™ or the barcodes in the USA Driver License Parsing Quick Reference Guide (QRG), available on the Datalogic website.

## Using the PowerScan™ PBT9501

The PowerScan™ PBT9501 reader normally functions by capturing and decoding bar codes. The reader is equipped with an internal Motionix™ motion-sensing function which activates the aiming system on device motion. The intelligent aiming system indicates the field of view which should be positioned over the bar code:

**Table 1. Aiming System**

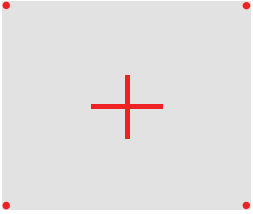
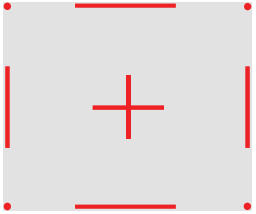
Model P/N	Aimer pattern
PBT9501/ PBT9501-DPM	
PBT9501-HP	



The field of view indicated by the aiming system will be smaller when the reader is closer to the bar code and larger when it is farther from the code. Symbologies with smaller bars or elements (mil size) should be read closer to the unit. Symbologies with larger bars or elements (mil size) should be read farther from the unit.

If the entire bar code is within the aiming field, you will get a good read. Successful reading is signaled by an audible tone plus a good-read green spot LED indicator.

Reference the PowerScan™ 9501 Product Reference Guide (PRG) for more information about this feature and other programmable settings.

## Installing the Battery Pack

To install, charge and/or do any other action on the battery, follow the instructions in this manual.



### NOTE

To charge the Battery Pack, See “Charging the Batteries” on page 6.

Datalogic recommends annual replacement of rechargeable battery packs to ensure maximum performance.



### WARNING

Do not discharge the battery using any device except for the scanner. When the battery is used in devices other than the designated product, it may damage the battery or reduce its life expectancy. If the device causes an abnormal current to flow, it may cause the battery to become hot, explode or ignite and cause serious injury.

Lithium-ion battery packs may get hot, explode or ignite and cause serious injury if exposed to abusive conditions. Be sure to follow the safety warnings that follow:

- Do not place the battery pack in fire or heat.
- Do not connect the positive terminal and negative terminal of the battery pack to each other with any metal object (such as wire).
- Do not carry or store the battery pack together with metal objects.



- Do not pierce the battery pack with nails, strike it with a hammer, step on it or otherwise subject it to strong impacts or shocks.
- Do not solder directly onto the battery pack.
- Do not expose the battery pack to liquids, or allow the battery to get wet.
- Do not apply voltages to the battery pack contacts.

In the event the battery pack leaks and the fluid gets into your eye, do not rub the eye. Rinse well with water and immediately seek medical care. If left untreated, the battery fluid could cause damage to the eye.



Always charge the battery at 32° – 104°F (0° - 40°C) temperature range.

Use only the authorized power supplies, battery pack, chargers, and docks supplied by your Datalogic reseller. The use of any other power supplies can damage the device and void your warranty.

Do not disassemble or modify the battery. The battery contains safety and protection devices, which, if damaged, may cause the battery to generate heat, explode or ignite.

Do not place the battery in or near fire, on stoves or other high temperature locations.

Do not place the battery in direct sunlight, or use or store the battery inside cars in hot weather. Doing so may cause the battery to generate heat, explode or ignite. Using the battery in this manner may also result in a loss of performance and a shortened life expectancy.

Do not place the battery in microwave ovens, high-pressure containers or on induction cookware.

Immediately discontinue use of the battery if, while using, charging or storing the battery, the battery emits an unusual smell, feels hot, changes color or shape, or appears abnormal in any other way.

**CAUTION**

**Do not replace the battery pack when the device is turned on.**

**Do not remove or damage the battery pack's label.**

**Do not use the battery pack if it is damaged in any part. Battery pack usage by children should be supervised.**

As with other types of batteries, Lithium-Ion (LI) batteries will lose capacity over time. Capacity deterioration is noticeable after one year of service whether the battery is in use or not. It is difficult to precisely predict the finite life of a LI battery, but cell manufacturers rate them at 500 charge cycles. In other words, the batteries should be expected to take 500 full discharge / charge cycles before needing replacement. This number is higher if partial discharging / recharging is adhered to rather than full / deep discharging.

The typical manufacturer advertised useful life of LI batteries is one to three years, depending on usage and number of charges, etc., after which they should be removed from service, especially in mission critical applications. Do not continue to use a battery that is showing excessive loss of capacity, it should be properly recycled / disposed of and replaced. For most applications, batteries should be replaced after one year of service to maintain customer satisfaction and minimize safety concerns.

Collect and recycle waste batteries separately from the device in comply with European Directive 2006/66/EC, 2011/65/EU, 2002/96/EC and 2012/19/EU and subsequent modifications, US and China regulatory and others laws and regulations about the environment.

## Charging the Batteries

Once the BC 90x0-BT is powered, you can charge the reader's batteries. Place the PowerScan™ PBT9501 into the BC 90x0-BT cradle. The Reader LED on the cradle/battery charger turns red.

The battery is completely charged when the Reader LED on the cradle/battery charger turns green.

The battery can also be charged in the spare battery slot (BC91xx models only) or using the Multi Battery Charger accessory.



## Changing the Batteries

1. Push the button at the bottom of the handle as shown to release the battery.
2. Pull down to remove the battery.



**WARNING**

**Do not incinerate, disassemble, short terminals or expose to high temperature. Risk of fire, explosion. Use specified charger only. Risk of explosion if the battery is replaced by an incorrect type. Dispose of the batteries as required by the relevant laws in force.**

## Programming

The reader is factory-configured with a set of standard default features. Customize your reader through use of the programming bar codes available in the PowerScan™ PBT9501. Check the corresponding features section for your interface, and also the Data Editing and Symbologies chapters of the PRG.

### Using Programming Bar Codes

This manual contains bar codes which allow you to reconfigure your reader. Some programming bar code labels, like the "Reset Default Settings" on page 8, require only the scan of that single label to enact the change.

Other bar codes require the reader to be placed in Programming Mode prior to scanning them. Scan an ENTER/EXIT bar code once to enter Programming Mode; scan the desired parameter settings; scan the ENTER/EXIT bar code again to accept your changes, which exits Programming Mode and returns the reader to normal operation.

### Configure Other Settings

Additional programming bar codes are available in the PRG to allow for customizing programming features. If your installation requires different programming than the standard factory default settings, refer to the PRG.

### Resetting Product Defaults

If you aren't sure what programming options are in your reader, or you've changed some options and want your custom factory settings restored, scan the bar code below to reset the reader to initial configuration. See the PRG for other options, and a listing of standard factory settings.



**NOTE**

**Factory defaults are based on the interface type. Be sure your reader is configured for the correct interface before scanning this label.**



Reset Default Settings

## Set Date and Time

1. Scan the Enter/Exit Programming barcode below to set date and time.

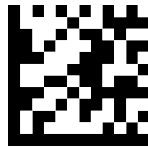

ENTER/EXIT PROGRAMMING MODE

2. Scan the Set Date barcode + six digits for Year, Month and Day (YYMMDD) from the [Hex-Numeric Keypad on page 33](#).



Set Date

3. Scan Set Time + six digits for Hours, Minutes and Seconds (HHMMSS) from the [Hex-Numeric Keypad on page 33](#).

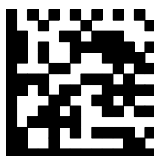

Set Time

4. Scan the Enter/Exit Programming barcode to complete.

---

## Linking the Reader

### Link Datalogic RF Devices to Base

For RF devices, before configuring the interface it is necessary to link the handheld with the base.

To link the handheld and the base, press the trigger to wake up the handheld and mount it into the base. If the reader was previously linked to another base, you must first press and hold the button on the base (>5 seconds), then scan the **Unlink** bar code before re-linking to the new base.

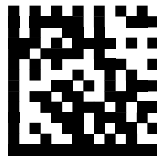

Unlink

### Linking to a Bluetooth Adapter in Serial Port Profile (Slave) Mode

1. Install any drivers provided with the Bluetooth adapter.
2. Scan the **Enable RF Link to Server** label below to make the scanner visible to the host computer.
3. Use the host computer's Bluetooth manager to 'Discover new devices' and select "Datalogic Scanner." If you receive an error message, it may be necessary to disable security on the device.
4. Use an RS-232 terminal program to see incoming data on the port designated by the computer's Bluetooth manager.

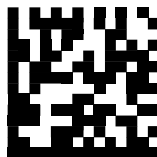

Enable RF Link to Server

## Linking to a Bluetooth Adapter in HID mode

1. Install any drivers provided with the Bluetooth adapter.
2. Scan the **Link to PC in HID** label below..
3. Use the host computer's Bluetooth manager to 'Discover new devices' and select "Datalogic Scanner." If you receive an error message, it may be necessary to disable security on the device.
4. Use a text editor to see incoming data on the port designated by the computer's Bluetooth manager.

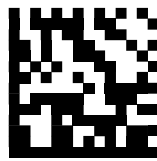

Link to PC in HID



### NOTE

The Powerscan™ PBT9501 can be set up to require a PIN code when connecting. If you want to set up a PIN, or when adding new equipment to a system that uses a custom security PIN, please see the PRG for information.



## Variable PIN Code

Some Bluetooth drivers on the Host (such as WIDCOMM and BlueSoleil 8) require a Variable PIN Code. When attempting connection, the application presents a window that includes a PIN Code which is to be input using the PowerScan™ PBT9501. Please read the bar code "Variable PIN Code" and restart the sequence from step 2 above.



Variable PIN Code

When you hear the beep and see the Green LED blinking indicating the reader is waiting for an alphanumeric entry, enter the required variable PIN Code by scanning the corresponding bar codes in the 'Hex-Numeric Keypad' section at the back of this manual for alphanumeric entry. Finish by scanning the **Exit HID Variable PIN Code** label.

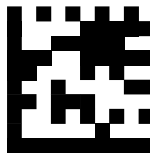

Exit HID Variable PIN Code

## HID Country Mode

When the Reader is connected with a Bluetooth Adapter in HID mode, you may want to set the country for which your PC is localized. In order to do that, read one of the configuration command labels below.

HID COUNTRY MODE
 ENTER/EXIT PROGRAMMING MODE
 Country Mode = U.S.
 Country Mode = Belgium
 Country Mode = Britain
 Country Mode = Croatia

**HID COUNTRY MODE (continued)**



Country Mode = Czech Republic

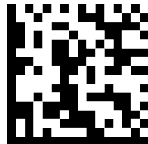

Country Mode = Denmark

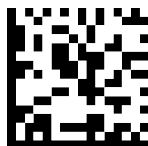

Country Mode = France

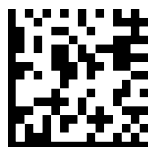

Country Mode = French Canadian

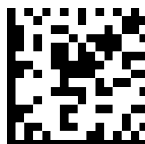

Country Mode = Germany

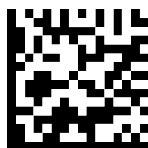

Country Mode = Hungary

**HID COUNTRY MODE (continued)**



Country Mode = Italy



Country Mode = Japanese 106-key

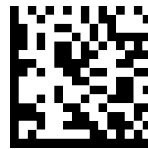

Country Mode = Lithuanian

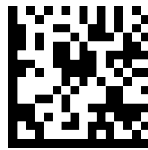

Country Mode = Norway

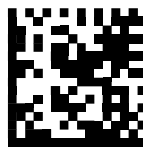

Country Mode = Poland



Country Mode = Portugal

**HID COUNTRY MODE (continued)**



Country Mode = Romania



Country Mode = Spain

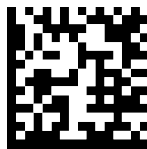

Country Mode = Sweden



Country Mode = Slovakia



Country Mode = Switzerland

## HID Caps Lock State

This option specifies the format in which the reader sends character data.

 ENTER/EXIT PROGRAMMING MODE
 ◆ Caps Lock State = Caps Lock OFF
 Caps Lock State = Caps Lock ON
 Caps Lock State = AUTO Caps Lock Enable



**BSR idware GmbH**

Jakob-Haringer-Str.3

A-5020 Salzburg

<https://www.bsr.at>

[sales@bsr.at](mailto:sales@bsr.at)

## HID Alt Mode

Read the configuration command label below for the HID Alt Mode feature.

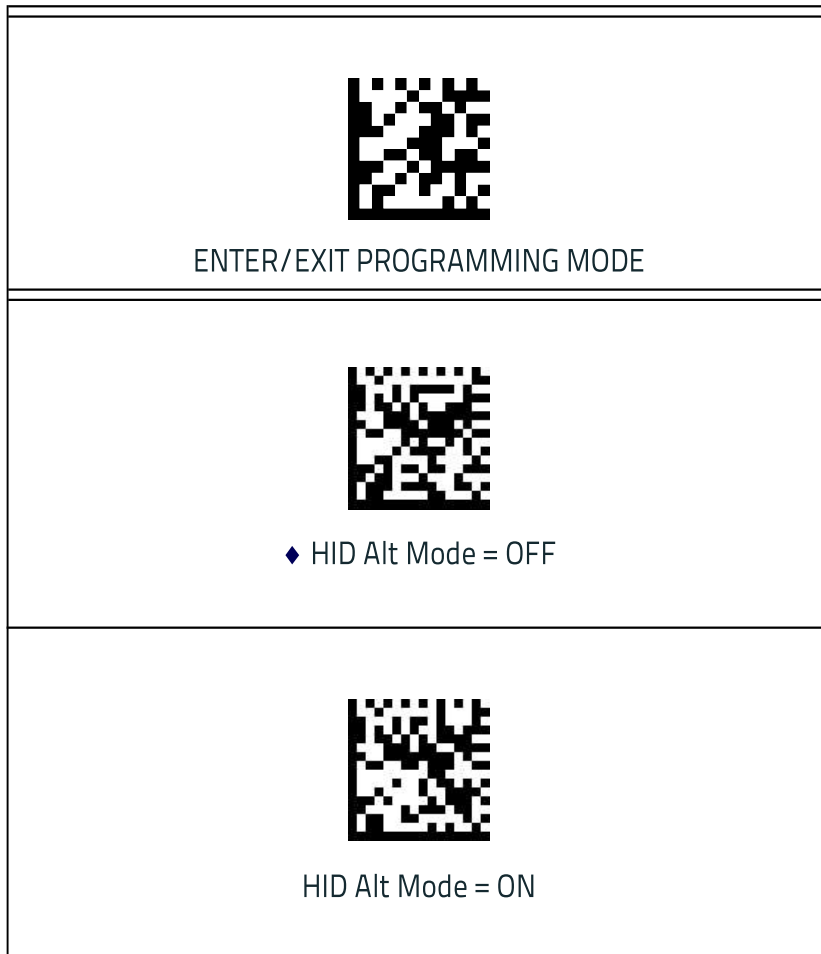

## Power Off

Scan the bar code below to shut off power to the BT handheld until the next trigger pull.



PowerOff

# Operating Mode

## Scan Mode

The imager can be set to operate in one of several scanning modes. See the PRG for more information and settings for any of the options:

**Trigger Single (Default)** — When the trigger is pulled, scanning is activated until one of the following occurs:

- a programmable duration<sup>1</sup> has elapsed
- a label has been read
- the trigger is released

**Trigger Hold Multiple** — When the trigger is pulled, scanning starts and the product scans until the trigger is released or 'maximum scan on time'<sup>1</sup> has elapsed. Reading a label does not disable scanning. Double Read Timeout<sup>1</sup> prevents undesired multiple reads in this mode.

**Trigger Pulse Multiple** — When the trigger is pulled and released, scanning is activated until programmable duration<sup>1</sup> has elapsed or the trigger has been pulled again to transition to another state. Double Read Timeout<sup>1</sup> prevents undesired multiple reads while in this mode.

**Flashing** — The reader flashes<sup>1</sup> on and off regardless of the trigger status.

**Always On** — No trigger pull is required to read a bar code. Scanning is continually on. If the trigger is pulled, the reader acts as if it is in Trigger Single (Default) Mode. Double Read Timeout<sup>1</sup> prevents undesired multiple reads while in this mode.

**Stand Mode** — No trigger pull is required to read a bar code. Scanning is turned on automatically when an item is placed in reader's field of view. If the trigger is pulled, the reader acts as if it is in Single Read mode. Double Read Timeout<sup>1</sup> prevents undesired multiple reads while in this mode.



1. See the Product Reference Guide (PRG) for more information

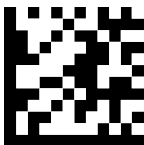

## Operating Mode (continued)

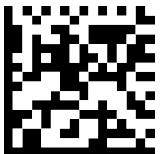
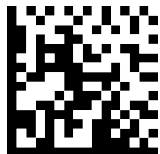

ENTER/EXIT PROGRAMMING MODE

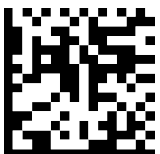
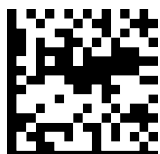
 <p>◆ Scan Mode = Trigger Single</p>	 <p>Scan Mode = Trigger Pulse Multiple</p>
 <p>Scan Mode = Trigger Hold Multiple</p>	 <p>Scan Mode = Flashing</p>
 <p>Scan Mode = Always On</p>	 <p>Scan Mode = Stand Mode</p>

## Motion Aiming Control

This feature configures the ability of the scanner to Enable/Disable the Aiming system when motion is detected (Motionix™ motion-sensing technology). Scan the Enter/Exit Programming bar code above, then either of the barcodes below.

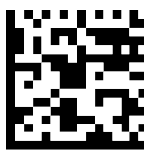
 <p>◆ Motion Aiming Control = Enable</p>	 <p>Motion Aiming Control = Disable</p>
---	---

## Pick Mode

Pick Mode is a Decoding and Transmission process where bar codes that are not within the configurable distance from the center of the aiming pattern are not acknowledged or transmitted to the host. It is active only in Trigger Single mode. If the scanner switches to a different Read Mode, Pick Mode is automatically disabled.



**This feature is not compatible with Multiple Labels Reading in a Volume. See the PRG for more information.**

### NOTE

 ENTER/EXIT PROGRAMMING MODE
 ◆ Pick Mode = Disable
 Pick Mode = Enable

## Multiple Label Reading

The reader offers a number of options for multiple label reading. See the PRG or software configuration tool for descriptions of these features and programming labels.

## Technical Specifications

The following tables contain Physical and Performance Characteristics, User Environment and Regulatory information.

Item	Description
<b>PHYSICAL CHARACTERISTICS</b>	
Dimensions	Height: 212 mm Length: 110 mm Width: 74 mm
Weight	PBT9501-RB PBT9501-HPRB                      400 g PBT9501-DPMRB
<b>ELECTRICAL CHARACTERISTICS</b>	
Battery Type	Li-Ion battery pack
Charge time for full charge from full discharge	4,5 hours with external power supply adapter <sup>a</sup>
	Typical 10 hours with Host power (in this case no supply adapter is needed) <sup>a</sup>
Operating autonomy (continuous reading)	60,000 reads (typical, @25° C)
Cradle consumption and DC input supply range	Volt 10-30 VDC; Power <8W <sup>b</sup> ; Max 500mA when in host/bus powered mode <sup>b</sup> .

- a. Charge Times are much lower when battery is within daily typical operating condition.
- b. Typical input current measured under factory default configuration.

<b>PERFORMANCE CHARACTERISTICS</b>		
Light Source	LED	
Roll (Tilt) Tolerance	± 180°	
Pitch Tolerance	± 40°	
Skew (Yaw) Tolerance	± 40°	
Print Contrast Minimum	15% minimum reflectance	

<b>Item</b>	<b>Description</b>	
Resolution	PBT9501	PBT9501-HP
	Max resolution 1D 4 mils Max resolution 2D 7.5 mils	1D 2.5 mil 2D 4 mil
<b>DEPTH OF FIELD (TYPICAL)<sup>a</sup></b>		
Symbology	Standard Model:	High Performance:
Code 39	4 mils: 6-17 cm 20 mils: 4-55 cm 40 mils: 4-85 cm	2.5 mils: 2-6 cm 20 mils: 3-70 cm 40 mils: 3-110 cm
EAN 13	13 mils: 4-48 cm	13 mils: 3-60 cm
PDF-417	10 mils: 2-25 cm	10 mils: 2-30 cm
DataMatrix	7.5 mils: 7-14 cm 10 mils: 4-18 cm	4 mil: 2-6 cm 10 mil: 2-20 cm

- a. 13 mils DOF based on EAN. All other 1D codes are Code 39. All labels grade A, 300 lux ambient light, 20°C, label inclination 10°

<b>Decode Capability</b>	
<p><b>1D Bar Codes</b>                      GS1 Databar linear codes, UPC/EAN (A,E,13,8), UPC/EAN with P2/P5 Addons, UPC/EAN Coupons, ISBN, Code128, EAN128, ISBT128, Code39, Code39 Full ASCII, Code39 CIP, Code 32, Codabar, Interleaved 2 of 5, IATA, Industrial 2 of 5, Standard 2 of 5, Code11, MSI, Plessey, Code 93, Follet 2/5</p>	
<p><b>2D / Stacked Codes</b>                      DataMatrix, MaxiCode and QR Codes (QR, Micro QR and Multiple QR codes), Aztec                      - Postal codes including:                      Australian Post, China Post, Japanese Post, KIX Post, Planet Code, Postnet, Royal Mail Code(RM45CC), IMB                      - Stacked codes including:                      EAN/JAN Composites; GS1 Databar Composites, GS1 Databar Expanded Stacked; GS1 DataBar Stacked; GS1 DataBar Stacked Omnidirectional; MacroPDF; Micro PDF417; PDF417; UPC A/E Composites, French CIP13, Grid Matrix(Chinese) code</p>	
Interfaces Supported	RS-232, Keyboard Wedge, and USB.
<b>USER ENVIRONMENT</b>	
Operating Temperature	-4° to 122° F (-20° - +50° C )
Storage Temperature	-40° to 158° F (-40° to 70° C)
Humidity	0 to 95% non-condensing
Drop Specifications	Scanner withstands up to 50 times 6.5' (2 m) drops to concrete
Ambient Light Immunity	100,000 Lux
Contaminants: Spray/rain, Dust/particulates	IP65
ESD Level	20 KV
Beeper/Speaker	>= 80 dB @ 10 cm

<b>REGULATORY</b>	
See the Regulatory Addendum.	
<b>RADIO FEATURES</b>	
Frequency working center	2400 to 2483.5 MHz
Range (in open air)	up to 100m
Max number of devices per base station	7

## LED and Beeper Indications

The reader's beeper sounds and its LED illuminates to indicate various functions or errors on the reader. An optional 'Green Spot' also performs useful functions. The following tables list these indications. One exception to the behaviors listed in the tables is that the reader's functions are programmable, and so may or may not be turned on. For example, certain indications such as the power-up beep can be disabled using programming bar code labels.

**Table 2. Normal Operating Indicators**

INDICATION	DESCRIPTION	LED	BEEPER
Power-up Beep	The reader is in the process of powering-up.	N/A	Reader beeps four times at highest frequency and volume upon power-up.
Good Read Beep	A label has been successfully scanned by the reader.	LED behavior is configurable via the feature 'Good Read: When to Indicate' (see the PRG for information.)	The reader will beep once at current frequency, volume, tonal setting and duration upon a successful label scan.
Green Spot <sup>a</sup> flashes momentarily	Upon successful read of a label, the software turns the green spot on for the time specified	N/A	N/A
Image Capture	When ready to capture image	Blue light flashes 2 times when updating	N/A

<sup>a</sup>Except when in sleep mode or when a Good Read LED Duration other than 00 is selected

**Table 3. Error Indicators**

<b>INDICATION</b>	<b>DESCRIPTION</b>	<b>LED</b>	<b>BEEPER</b>
Link Attempt	The reader is trying to link to the base	Slow Flashes	N/A
Configuration Alignment	Reader and Base are aligning the parameters' configuration	Fast Flashes	N/A
Link	The reader has successfully linked to the base	N/A	3 beeps of ascending frequency
Unlink	The reader has unlinked from the base	N/A	3 beeps of descending frequency
ROM Failure	There is an error in the reader's software/programming	Flashes	Reader sounds one error beep at highest volume.
Limited Scanning Label Read	Indicates that a host connection is not established.	N/A	Reader 'chirps' six times at the highest frequency and current volume.
Reader Disabled	The reader has been disabled by the host.	The LED blinks continuously	N/A

**Programming Mode** - The following indications ONLY occur when the reader is in Programming Mode.

<b>INDICATION</b>	<b>DESCRIPTION</b>	<b>LED</b>	<b>BEEPER</b>
Label Programming Mode Entry	A valid programming label has been scanned.	LED blinks continuously	Reader sounds four low frequency beeps.
Label Programming Mode Rejection of Label	A label has been rejected.	N/A	Reader sounds three times at lowest frequency and current volume.



INDICATION	DESCRIPTION	LED	BEEPER
Label Programming Mode Acceptance of Partial Label	In cases where multiple labels must be scanned to program one feature, this indication acknowledges each portion as it is successfully scanned.	N/A	Reader sounds one short beep at highest frequency and current volume.
Label Programming Mode Acceptance of Programming	Configuration option(s) have been successfully programmed via labels and the reader has exited Programming Mode.	N/A	Reader sounds one high frequency beep and 4 low frequency beeps followed by reset beeps.
Label Programming Mode Cancel Item Entry	Cancel label has been scanned.	N/A	Reader sounds two times at low frequency and current volume.

## Error Codes

Upon startup, if the reader sounds a long tone, this means the reader has not passed its automatic Selftest and has entered FRU (Field Replaceable Unit) isolation mode. If the reader is reset, the sequence will be repeated. Press and release the trigger to hear the FRU indication code.

The following table describes the LED flashes/beep codes associated with an error found.

Number of LED Flashes/Beeps	Error	Corrective Action
1	Configuration	Contact Helpdesk for assistance
2	Interface PCB	
6	Digital PCB	
11	Imager	

## Cleaning

Exterior surfaces and scan windows exposed to spills, smudges or debris require periodic cleaning to ensure best performance during scanning.

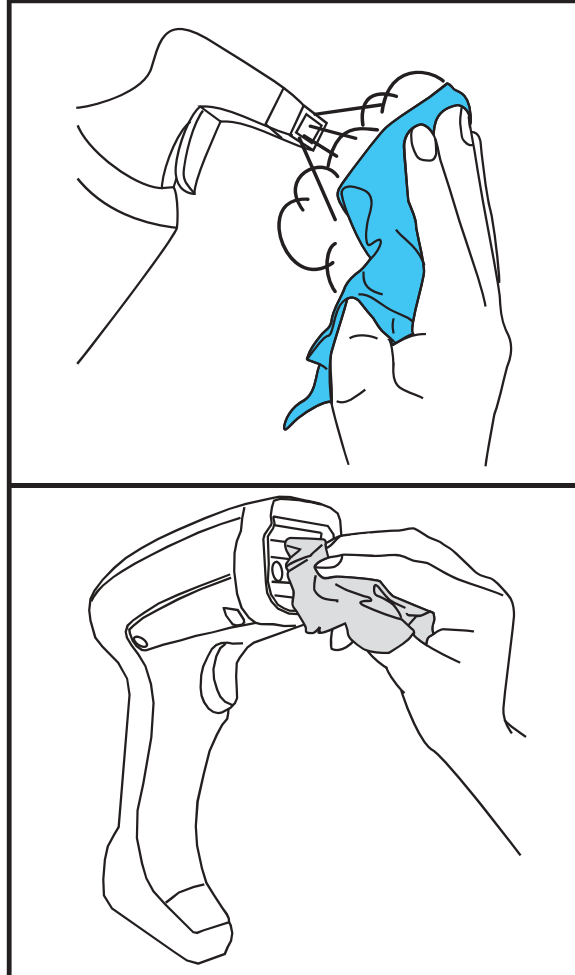

Use a soft, dry cloth to clean the product. If the product is very soiled, clean it with a soft cloth moistened with a diluted non-aggressive cleaning solution or diluted ethyl alcohol.



**CAUTION**

**Do not use abrasive or aggressive cleansing agents or abrasive pads to clean scan windows or plastics.**

**Do not spray or pour liquids directly onto the unit.**

# Datalogic Limited Factory Warranty

## Warranty Coverage

Datalogic warrants to Customer that Datalogic's products will be free from defects in materials and workmanship for a period of one year from product shipment. Datalogic hardware products are warranted against defects in material and workmanship under normal and proper use. The liability of Datalogic under this warranty is limited to furnishing the labor and parts necessary to remedy any defect covered by this warranty and restore the product to its normal operating condition. Repair or replacement of product during the warranty does not extend the original warranty term. Products are sold on the basis of specifications applicable at the time of manufacture and Datalogic has no obligation to modify or update products once sold.

If Datalogic determines that a product has defects in material or workmanship, Datalogic shall, at its sole option repair or replace the product without additional charge for parts and labor, or credit or refund the defective products duly returned to Datalogic. To perform repairs, Datalogic may use new or reconditioned parts, components, subassemblies or products that have been tested as meeting applicable specifications for equivalent new material and products. Customer will allow Datalogic to scrap all parts removed from the repaired product. The warranty period shall extend from the date of shipment from Datalogic for the duration published by Datalogic for the product at the time of purchase (Warranty period). Datalogic warrants repaired hardware devices against defects in workmanship and materials on the repaired assembly for a 90 day period starting from the date of shipment of the repaired product from Datalogic or until the expiration of the original warranty period, whichever is longer. Datalogic does not guarantee, and it is not responsible for, the maintenance of, damage to, or loss of configurations, data, and applications on the repaired units and at its sole discretion can return the units in the 'factory default' configuration or with any software or firmware update available at the time of the repair (other than the firmware or software installed during the manufacture of the product). Customer accepts responsibility to maintain a back up copy of its software and data.

## Warranty Claims Process

In order to obtain service under the Factory Warranty, Customer must notify Datalogic of the claimed defect before the expiration of the applicable Warranty period and obtain from Datalogic a return authorization number (RMA) for return of the product to a designated Datalogic service center. If Datalogic determines Customer's claim is valid, Datalogic will repair or replace product without additional charge for parts and labor. Customer shall be responsible for packaging and shipping the product to the designated Datalogic service center, with shipping charges prepaid. Datalogic shall pay for the return of the product to Customer if the shipment is to a location within the country in which the Da-

Datalogic service center is located. Customer shall be responsible for paying all shipping charges, duties, taxes, and any other charges for products returned to any other locations. Failure to follow the applicable RMA policy, may result in a processing fee. Customer shall be responsible for return shipment expenses for products which Datalogic, at its sole discretion, determines are not defective or eligible for warranty repair.

### **Warranty Exclusions**

The Datalogic Factory Warranty shall not apply to:

- (i) any product which has been damaged, modified, altered, repaired or upgraded by other than Datalogic service personnel or its authorized representatives;
- (ii) any claimed defect, failure or damage which Datalogic determines was caused by faulty operations, improper use, abuse, misuse, wear and tear, negligence, improper storage or use of parts or accessories not approved or supplied by Datalogic;
- (iii) any claimed defect or damage caused by the use of product with any other instrument, equipment or apparatus;
- (iv) any claimed defect or damage caused by the failure to provide proper maintenance, including but not limited to cleaning the upper window in accordance with product manual;
- (v) any defect or damage caused by natural or man-made disaster such as but not limited to fire, water damage, floods, other natural disasters, vandalism or abusive events that would cause internal and external component damage or destruction of the whole unit, consumable items;
- (vi) any damage or malfunctioning caused by non-restoring action as for example firmware or software upgrades, software or hardware reconfigurations etc.;
- (vii) the replacement of upper window/cartridge due to scratching, stains or other degradation and/or
- (viii) any consumable or equivalent (e.g., cables, power supply, batteries, keypads, touch screen, triggers etc.).

### **No Assignment**

Customer may not assign or otherwise transfer its rights or obligations under this warranty except to a purchaser or transferee of product. No attempted assignment or transfer in violation of this provision shall be valid or binding upon Datalogic.

DATALOGIC'S LIMITED WARRANTY IS IN LIEU OF ALL OTHER WARRANTIES, EXPRESS OR IMPLIED, ORAL OR WRITTEN, STATUTORY OR OTHERWISE, INCLUDING, WITHOUT LIMITATION, ANY IMPLIED WARRANTIES OF MERCHANTABILITY, FITNESS FOR A PARTICULAR PURPOSE, OR NONINFRINGEMENT. DATALOGIC SHALL NOT BE LIABLE FOR ANY DAMAGES SUSTAINED BY CUSTOMER ARISING FROM DELAYS IN THE REPLACEMENT OR REPAIR OF PRODUCTS UNDER THE ABOVE. THE REMEDY SET FORTH IN THIS WARRANTY STATEMENT IS THE CUSTOMER'S SOLE AND EXCLUSIVE REMEDY FOR WARRANTY CLAIMS. UNDER NO CIRCUMSTANCES WILL DATALOGIC BE LIABLE TO CUSTOMER

OR ANY THIRD PARTY FOR ANY LOST PROFITS, OR ANY INCIDENTAL, CONSEQUENTIAL IN-DIRECT, SPECIAL OR CONTINGENT DAMAGES REGARDLESS OF WHETHER DATALOGIC HAD ADVANCE NOTICE OF THE POSSIBILITY OF SUCH DAMAGES.

### **Risk of Loss**

Customer shall bear risk of loss or damage for product in transit to Datalogic. Datalogic shall assume risk of loss or damage for product in Datalogic's possession. In the absence of specific written instructions for the return of product to Customer, Datalogic will select the carrier, but Datalogic shall not thereby assume any liability in connection with the return shipment.

## **Ergonomic Recommendations**



**CAUTION**

**In order to avoid or minimize the potential risk of ergonomic injury follow the recommendations below. Consult with your local Health & Safety Manager to ensure that you are adhering to your company's safety programs to prevent employee injury.**

- Reduce or eliminate repetitive motion
- Maintain a natural position
- Reduce or eliminate excessive force
- Keep objects that are used frequently within easy reach
- Perform tasks at correct heights
- Reduce or eliminate vibration
- Reduce or eliminate direct pressure
- Provide adjustable workstations
- Provide adequate clearance
- Provide a suitable working environment
- Improve work procedures.

## Support Through the Website

Datalogic provides several services as well as technical support through its website. Log on to [www.datalogic.com](http://www.datalogic.com):

For quick access, from the home page click on the search icon , and type in the name of the product you're looking for. This allows you access to download Data Sheets, Manuals, Software & Utilities, and Drawings.

Hover over the Support & Service menu for access to Services and Technical Support.

## Hex-Numeric Keypad

Use the barcodes that follow to enter numbers as you would select digits/characters from a keypad.

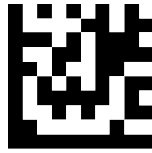

0

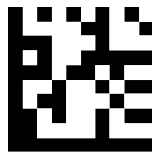

1

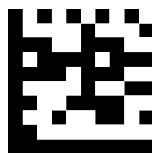

2

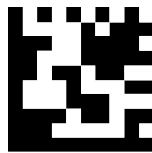

3

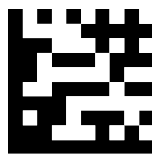

4

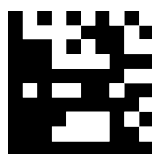

5

## Hex-Numeric Keypad (continued)

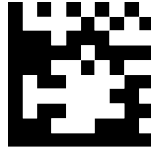

6

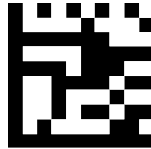

7

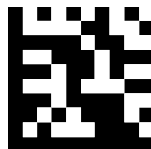

8

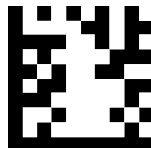

9

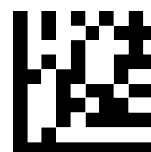

A

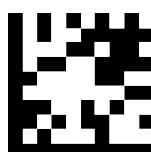

B



## Hex-Numeric Keypad (continued)

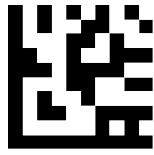

C

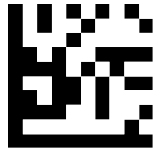

D

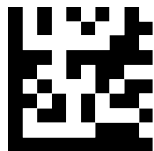

E

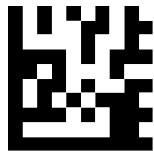

F

### For HID Variable Pin Code only

If you make a mistake, scan the **CANCEL** barcode below to abort and not save the entry string. You can then restart.

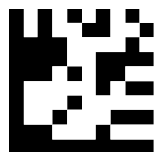

Cancel an incomplete HID Variable PIN Code

Finish by scanning the **Exit HID Variable PIN Code** label.

Exit HID Variable PIN Code

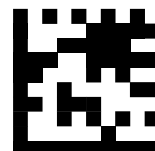

# NOTES





**BSR idware GmbH**

Jakob-Haringer-Str.3

A-5020 Salzburg

<https://www.bsr.at>

[sales@bsr.at](mailto:sales@bsr.at)



[www.datalogic.com](http://www.datalogic.com)

©2013-2019 Datalogic S.p.A. and/or its affiliates. All rights reserved. Datalogic and the Datalogic logo are registered trademarks of Datalogic S.p.A. in many countries, including the U.S. and the E.U.

**Datalogic USA Inc.**

959 Terry Street | Eugene, OR 97402 | U.S.A. |

Telephone: (541) 683-5700 |

Fax: (541) 345-7140



820104800

Rev. A

June 2019