



BSR idware GmbH

Jakob-Haringer-Str.3

A-5020 Salzburg

<https://www.bsr.at>

sales@bsr.at

VC8300

8" Vehicle-Mounted Computer



User Guide for Android™ 10



ZEBRA

ZEBRA and the stylized Zebra head are trademarks of Zebra Technologies Corporation, registered in many jurisdictions worldwide. Google, Android, Google Play and other marks are trademarks of Google LLC; All other trademarks are the property of their respective owners. ©2021 Zebra Technologies Corporation and/or its affiliates. All rights reserved.

COPYRIGHTS & TRADEMARKS: For complete copyright and trademark information, go to zebra.com/copyright.

WARRANTY: For complete warranty information, go to zebra.com/warranty.

END USER LICENSE AGREEMENT: For complete EULA information, go to zebra.com/eula.

Terms of Use

- **Proprietary Statement**

This manual contains proprietary information of Zebra Technologies Corporation and its subsidiaries (“Zebra Technologies”). It is intended solely for the information and use of parties operating and maintaining the equipment described herein. Such proprietary information may not be used, reproduced, or disclosed to any other parties for any other purpose without the express, written permission of Zebra Technologies.
- **Product Improvements**

Continuous improvement of products is a policy of Zebra Technologies. All specifications and designs are subject to change without notice.
- **Liability Disclaimer**

Zebra Technologies takes steps to ensure that its published Engineering specifications and manuals are correct; however, errors do occur. Zebra Technologies reserves the right to correct any such errors and disclaims liability resulting therefrom.
- **Limitation of Liability**

In no event shall Zebra Technologies or anyone else involved in the creation, production, or delivery of the accompanying product (including hardware and software) be liable for any damages whatsoever (including, without limitation, consequential damages including loss of business profits, business interruption, or loss of business information) arising out of the use of, the results of use of, or inability to use such product, even if Zebra Technologies has been advised of the possibility of such damages. Some jurisdictions do not allow the exclusion or limitation of incidental or consequential damages, so the above limitation or exclusion may not apply to you.

Revision History

Changes to the original guide are listed below:

Change	Date	Description
-01 Rev A	9/2020	Initial release
-02 Rev A	10/2021	Updated GMS Restricted topic.

Table of Contents

About This Guide	11
Introduction	11
Configurations	11
Software Versions	11
Chapter Descriptions.....	12
Notational Conventions	12
Related Documents and Software	13
Service Information	13
Getting Started	14
Introduction	14
Unpacking	14
Removing the Protective Film from the Display.....	14
Safety	14
Initial Operation Safety Considerations	15
Power Supply/Cable Safety	15
External Devices Safety	15
Features	16
Front Keys and LED Indicators	19
Front Keys	19
LED Indicators	19
Integrated Keyboard.....	20
Soft Input Panel.....	22
Powering Up the Device.....	22
Powering Down the Device	22
Setting Up WLAN	22
Device Settings	22
Heater Status	22

Table of Contents

Installation	23
Introduction	23
Overview	23
Mounting Instructions	23
Installing the Device	23
Electrical Installation	23
Wiring Guidelines	24
Wiring Vehicle Power to the VC8300	25
External Antenna Installation	26
Positioning the VC8300 in the Vehicle	26
Overview of the Assembly Steps	26
Cable Dust Cover	26
Strain Relief	27
Installing the VC8300 on a Forklift.....	27
Forklift Battery Replacement Conditions	28
Starting from Cold Soak	28
Pre-Heat Mode	29
Installing the Power Pre-Regulator	29
Non-Vehicle Installations.....	30
Screen Blanking Wiring.....	31
Connecting Switch for Screen Blanking	31
Using the Device	33
Home Screen	33
Setting Home Screen Rotation	34
Status Bar	34
Notification Icons	35
Status Icons	36
Managing Notifications	37
Opening the Quick Access Panel	37
Quick Access Panel Icons.....	38
Editing Icons on the Quick Settings Bar	38
Battery Management.....	39
Monitoring Battery Usage	39
Low Battery Notification	39
Waking the Device	39
USB Communication.....	40
Transferring Files.....	40
Transferring Photos	40
Disconnect from the Host Computer	40
Transferring Files	40

Table of Contents

Using a USB Drive.....	41
Disconnecting USB Drive	41
Applications	42
Accessing Apps.....	45
Switching Between Recent Apps.....	45
Battery Manager.....	45
Opening Battery Manager	45
Battery Manager Information Tab.....	45
DataWedge Demonstration.....	47
Scanner Selection	48
Heater Control.....	49
Temperatures	49
Serial Port Heater	49
USB Port Heater	49
Battery Heater	49
Touch Panel Heater.....	50
Keyboard Heater	50
PTT Express Voice Client	50
Speaker/Microphone Setup	50
PTT Audible Indicators	50
PTT Notification Icons	51
Enabling PTT Communication.....	51
Selecting a Talk Group	52
PTT Communication.....	52
Creating a Group Call	52
Responding with a Private Response	52
Disabling PTT Communication	52
RxLogger.....	53
RxLogger Configuration.....	53
Configuration File	53
Enabling Logging	53
Disabling Logging	53
Extracting Log Files	53
Backing Up	53
RxLogger Utility	54
Initiating the Main Chat Head.....	54
Removing the Main Chat Head	54
Viewing Logs.....	54
Removing a Sub Chat Head Icon.....	54
Backing Up In Overlay View.....	54
VC Settings	55

Table of Contents

Display	55
Peripheral Power	55
Ignition Detection	55
WIFI Antenna Switching	55
Built-In Speaker	55
Screen Blanking	55
Velocity.....	56
Data Capture	57
Imaging	58
Operational Modes	58
Laser Scanning	58
Scanning Considerations	58
Barcode Capture with RS6000 Bluetooth Ring Scanner.....	59
Barcode Capture with RS507/RS507x Hands-Free Imager.....	60
Bar Code Capture with RS5100.....	61
Bar Code Capture with Zebra Scanner	63
Connecting an RS-232 Scanner	63
Connecting a USB Scanner	65
Connecting Using Simple Serial Interface.....	65
Connecting Using HID Mode.....	66
Pairing the Ring Scanner	66
Pairing Using Simple Serial Interface	66
Pairing Using Human Interface Device.....	67
Pairing a DS3678 Scanner.....	68
Pairing Using Simple Serial Interface	68
Pairing a DS3678 Scanner Using Human Interface Device	69
DataWedge	69
Enabling DataWedge.....	69
Disabling DataWedge.....	70
DataWedge	70
Enabling DataWedge.....	70
Disabling DataWedge.....	70
Supported Decoders.....	70
Wireless	73
Wireless Local Area Networks	73
Connecting to a Wi-Fi Network.....	74
Removing a Wi-Fi Network.....	74
WLAN Configuration	74

Table of Contents

Configuring a Secure Wi-Fi Network	74
Manually Adding a Wi-Fi Network	75
Configuring for a Proxy Server	76
Configuring the Device to Use a Static IP Address	77
Wi-Fi Preferences	77
Additional Wi-Fi Settings	78
Wi-Fi Direct.....	79
Zebra Mobility Extensions	79
Bluetooth	79
Adaptive Frequency Hopping	80
Security.....	80
Bluetooth Profiles	80
Bluetooth Power States	81
Bluetooth Radio Power	82
Enabling Bluetooth	82
Disabling Bluetooth	82
Discovering Bluetooth Device(s)	82
Changing the Bluetooth Name	82
Connecting to a Bluetooth Device	83
Selecting Profiles on the Bluetooth Device.....	83
Unpairing a Bluetooth Device	83
Cast.....	83
Accessories and Mounting	84
Introduction	84
Accessories.....	84
VC8300 Antenna Options	85
VC8300 Mounting Accessories	87
MT43XX RAM Mount.....	88
Optional Mounts	88
Plate Bases for MT35XX Mounts	90
MT4200 Quick Release Mount	92
Assembling MT4200	92
Attaching MT4200 to VC8300	93
MT4210 Adapter Bracket.....	94
Settings.....	95
Accessing Settings.....	95
Display Settings	95
Setting the Screen Brightness Manually.....	95
Setting Night Light	95

Table of Contents

Setting Screen Rotation.....	96
Setting Screen Timeout.....	96
Lock Screen Display.....	96
Setting Font Size.....	96
Touch Panel Mode.....	97
Setting the Date and Time.....	97
Keyboard Backlight.....	98
General Sound Setting.....	98
Sound Options.....	98
Remapping a Button.....	99
Keyboards.....	99
Keyboard Configuration.....	99
Enabling Keyboards.....	99
Switching Between Keyboards.....	100
Using the Android and Gboard Keyboards.....	100
Edit Text.....	100
Entering Numbers, Symbols, and Special Characters.....	100
Using the Enterprise Keyboard.....	100
Numeric Tab.....	100
Alpha Tab.....	101
Additional Character Tab.....	101
Scan Tab.....	101
Soft Input Panel.....	103
Language Usage.....	104
Changing the Language Setting.....	104
Adding Words to the Dictionary.....	104
Notifications.....	104
Setting App Notifications.....	104
Viewing Notification Settings for All Apps.....	105
Controlling Lock Screen Notifications.....	105
Blink Light.....	105
Application Deployment.....	106
Security.....	106
Secure Certificates.....	106
Installing a Secure Certificate.....	106
Configuring Credential Storage Settings.....	107
Development Tools.....	107
Android Application Development.....	107
Development Workstation.....	107
Enabling Developer Options.....	107
EMDK for Android.....	108

Table of Contents

StageNow	108
GMS Restricted.....	108
ADB USB Setup	108
Enabling USB Debugging.....	108
Application Installation	109
Installing Applications Using a USB Drive	109
Installing Applications Using the USB Connection	110
Installing Applications Using the Android Debug Bridge	110
Uninstalling an Application	112
Performing a System Update.....	112
Downloading the System Update Package	112
Performing a System Update Using USB Drive	112
Performing a System Update Using ADB.....	113
Verifying System Update Installation.....	114
Enterprise Reset	114
Performing an Enterprise Reset From Device Settings.....	114
Downloading the Enterprise Reset Package	114
Performing an Enterprise Reset Using ADB.....	115
Performing a Factory Reset.....	116
Downloading the Factory Reset Package	116
Performing a Factory Reset Using ADB.....	117
Storage.....	118
Random Access Memory	118
Viewing Memory.....	118
Internal Storage	118
Viewing Internal Storage	118
External Storage.....	119
Viewing External Storage.....	119
Formatting a USB Drive as Portable Storage	119
Enterprise Folder	119
Managing Apps	119
App Details	119
Managing Downloads.....	120
Maintenance and Troubleshooting	121
Introduction	121
Cleaning	121
Housing Cleaning	121
Touchscreen Cleaning.....	121
Touchscreen	121
Troubleshooting	122

Table of Contents

Resetting the Device	122
Performing a Soft Reset.....	122
Performing a Hard Reset	122
VC8300.....	123
Specifications	126
Drill Hole Dimensions.....	126
Index	127

About This Guide

Introduction

This guide provides instructions for setting up, operating, configuring, and maintaining the VC8300 8 inch vehicle-mount computer.



NOTE: Screens and windows pictured in this guide are samples and can differ from actual screens.



WARNING: Before transporting, assembling, and starting the computer, please read this manual carefully and follow all the safety guidelines and requirements.

Configurations

The VC8300 offers different configurations to suit various work requirements. Some of the configuration options include:

- Qualcomm Snapdragon 660 octa-core 2.2 GHz
- 4 GB RAM/ 32 GB Flash
- Sunlight Readable Display
- Internal and External Antenna
- Freezer Condensing
- Android 10 Google™ Mobile Services (GMS)
- Basic I/O.



NOTE: For detailed configuration and part number information, contact your Zebra representative.

Software Versions

To determine the current software versions:

1. Swipe down from the Status bar to open the Quick Settings bar.
2. Touch **⚙ > System**.
3. Touch **About phone**.
4. Scroll to view the following information:
 - **Model**

- **Android version**
- Android security patch level
- **Kernel version**
- **Build number.**

To determine the device serial number, touch **About phone> Status**.

- **Serial number**

Chapter Descriptions

Topics covered in this guide are as follows:

- [Getting Started](#) provides information on safety guidelines and initial VC8300 setup.
- [Installation](#) provides instructions on installing the VC8300.
- [Using the Device](#) provides information for operating the VC8300.
- [Applications](#) provides information on using applications installed on the VC8300.
- [Data Capture](#) explains how to capture data using the optional scanners.
- [Wireless](#) provides information on the various wireless options.
- [Accessories and Mounting](#) describes the accessories and mounting options available for the VC8300.
- [Settings](#) provides the settings for configuring the VC8300.
- [Application Deployment](#) provides information for developing and managing applications.
- [Maintenance and Troubleshooting](#) includes instructions on cleaning the VC8300 and provides troubleshooting solutions for potential problems during device operations.
- [Specifications](#) summarizes the device's intended operating environment and technical specifications.

Notational Conventions

The following conventions are used in this document:

- **Bold** text is used to highlight the following:
 - Dialog box, window and screen names
 - Drop-down list and list box names
 - Check box and radio button names
 - Icons on a screen
 - Key names on a keypad
 - Button names on a screen.
 - Chapters and sections in this guide
- Bullets (•) indicate:
 - Action items
 - Lists of alternatives
 - Lists of required steps that are not necessarily sequential.
- Sequential lists (e.g., those that describe step-by-step procedures) appear as numbered lists.

Related Documents and Software

The following document provides more information about the VC8300 vehicle-mount computer.

- VC8300-8 Quick Reference Guide, p/n MN-003394-xx - includes setup information and regulatory information.
- U-Mount Bracket Installation Guide, p/n MN-002931-xx - includes the instructions to install the U-Mount Bracket Kit (KT-U-MOUNT-VC80-R) and dimensions.
- Adapter Bracket Kit for VC50 U-Mount Installation Guide, p/n MN-002932-xx - provides instruction on installing the Adapter Bracket Kit (MNT-VC80-ADPA1-1) to attach the VC8300 to the VC5090 U-Mount.
- Adapter Bracket Kit for Honeywell U-Mount Installation Guide, p/n MN-002934-xx - provides instruction on installing the Adapter Bracket Kit (MNT-VC80-ADPB1-1) to attach the VC8300 to the Honeywell U-Mount Bracket.

For the latest version of this guide and all guides, go to: zebra.com/support.

Service Information

If you have a problem with your equipment, contact Zebra Customer Support for your region. Contact information is available at: zebra.com/support.

When contacting support, please have the following information available:

- Serial number of the unit
- Model number or product name
- Software type and version number.

Zebra responds to calls by email, telephone or fax within the time limits set forth in support agreements.

If your problem cannot be solved by Zebra Customer Support, you may need to return your equipment for servicing and will be given specific directions. Zebra is not responsible for any damages incurred during shipment if the approved shipping container is not used. Shipping the units improperly can possibly void the warranty.

If you purchased your Zebra business product from a Zebra business partner, contact that business partner for support.

Getting Started

Introduction

The VC8300 is a rugged, vehicle mounted computer running Android 10 operating systems. Wireless communications are supported over a 802.11 WLAN network. The Bluetooth module supports Bluetooth printers and scanners. The VC8300-8 contains an integrated keyboard in either QWERTY or AZERTY alphanumeric keyboard layout. It features 54 keys, 12 direct function keys, and a power button.

The VC8300 is intended for use in commercial and industrial applications with a focus on real time wireless data transactions with options suiting materials handling applications in warehouses, manufacturing facilities, ports, yards, and freezers.

Unpacking



CAUTION: Before operating the unit for the first time, carefully read [Safety on page 14](#).



NOTE: Configure the VC8300 before fastening it to machines or vehicles.

Carefully remove all protective material from the device and save the shipping container for later storage and shipping.

Inspect the equipment for damage. If any equipment is missing or damaged, contact the Zebra Support Center immediately. See [Service Information on page 13](#) for contact information.

Removing the Protective Film from the Display

The front display of the VC8300 is protected during transport by a transparent film. This film should remain on the front display during assembly to avoid damage to the front display surface. Only remove the film once all of the assembly work has been completed.

Safety

In order to prevent injury and damage, observe the following safety guidelines prior to assembly and commissioning. The VC8300 is a multifunction vehicle computer for stationary and mobile use in commercial environments such as, warehouses, manufacturing, yard/ports, and freezers. Different or extraordinary usage is not permitted. For resulting damage, the user/operator of the VC8300 is solely responsible. This also applies to any changes that you make to the device. Compliance with the safety guidelines is particularly important for the proper use of this device. The manufacturer assumes no liability for any and all damages that can be attributed to non-compliance with these guidelines.

Initial Operation Safety Considerations

- Installation/Initial Operation - Perform VC8300 installation in accordance with [Installation on page 23](#). Specifically, pay special attention to the various electrical potentials of the vehicle. Some vehicles have a chassis that is connected to one of the battery supply lines (DC+ or DC-), while most electrically-driven forklift vehicles have floating chassis, connected to neither DC+ or DC-. See [Wiring Vehicle Power to the VC8300 on page 25](#) for required wiring of vehicle power and fusing for the VC8300.
- Risk of injury during transit or installation - The unit can fall during transit or installation and cause injury. Always ensure that there are two persons available when installing or removing the device.
- Ensure that no persons are injured in case the mounting bracket breaks - The VC8300 may not be installed in such a way that persons can be injured during a breaking of the mounting bracket (e.g. fatigue break). If the device is mounted in a place where people can be injured if the bracket breaks, apply appropriate safety measures (e.g. install a security cable in addition to the device bracket).

Power Supply/Cable Safety

The main power cord shall comply with the national safety regulations of the country where the equipment is to be used.

- Operation in an emergency - In case of an emergency (such as damage to the power cable or housing, or ingress of liquid or other foreign bodies), disconnect the device immediately from the power supply. Contact technical support staff at once.
- Protection of the power supplies - If, after replacement, the fuse fed by the internal power supply blows, send the device for servicing immediately.
- Danger of electrocution when cleaning/servicing the device - In order to avoid electrocution, always disconnect the VC8300 from the power supply before cleaning or servicing the device.
- Do not exceed maximum voltage when charging the vehicle battery - While charging the vehicle battery, disconnect the VC8300 from the battery or ensure that the maximum allowed input voltage of the VC8300 is not exceeded.
- Do not switch on devices with damaged cables or plugs - Do not use the VC8300 if a cable or plug is damaged. Replace damage parts immediately.
- Do not connect or disconnect cables during storms - Cables must never be connected or disconnected during an electrical storm.

External Devices Safety

The use of additional wiring and other peripheral devices, which are not recommended or sold by the manufacturer, can result in fire, electrocution or personal injury.

- If a power supply is used, only use the power supply recommended by the manufacturer.
- Before connecting or disconnecting peripheral devices (exception: USB devices), disconnect the VC8300 from the power supply to avoid serious damage to both the VC8300 and the connected devices.

Features

Figure 1 VC8300 8 inch Front View



1	Capacitive Touch Screen
2	Power Button
3	Programmable Keys
4	Blue Modifier Key
5	Pairing Bar Code
6	Enter Key
7	Diamond Key
8	Speaker
9	Unpairing Bar Code
10	Programmable Keys
11	Warning LED
12	Power LED

Getting Started

Figure 2 VC8300 8 inch Top View

802.11 a/b/g/n/ac Radio External Antenna Connectors

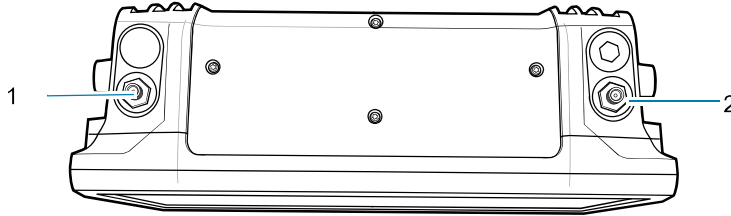

ANT 1 - Reverse Polarity SMA Jack (WLAN & BT) / External Main Antenna

ANT 2 - Reverse Polarity SMA Jack (WLAN) / External Aux Antenna

1	ANT 1
2	ANT 2



NOTE: Optional external Wi-Fi antennas are not shipped with the device and must be ordered as a separate accessory. The device can be switched between internal and external antenna. For a complete list of configurations see [Table 12 on page 84](#).

Figure 3 VC8300 Back View with Dust Cover

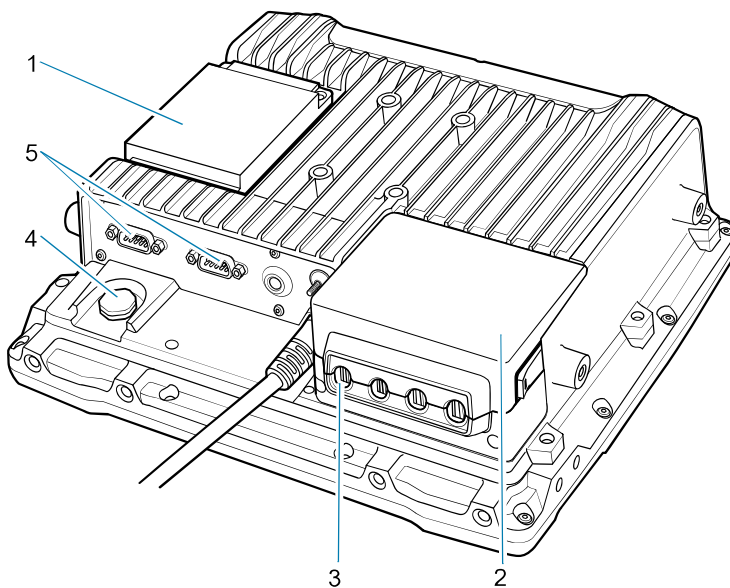

1	UPS Battery
2	Dust Cover
3	Strain Relief (four)
4	Vent
5	RS-232 (two)

Figure 4 VC8300 Back View without Dust Cover

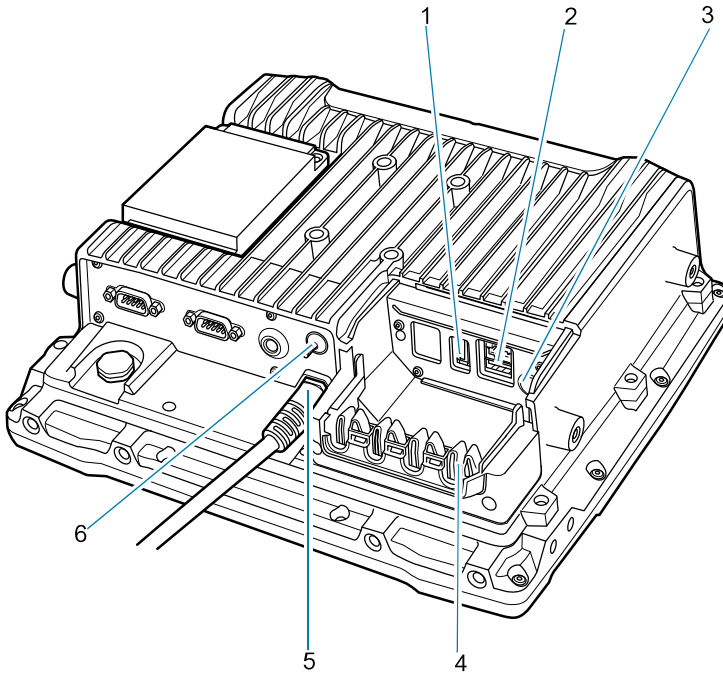

1	Standard USB
2	Powered USB
3	Speaker/Mic for M1000 only
4	Strain Relief
5	Power
6	Ground Lug

Front Keys and LED Indicators

The device has the following front bezel keys and LEDs:

Front Keys

Table 1 VC8300 8 inch Front Keys

Front	Function
Power	Powers the device on or off. Use to reset the device. See Resetting the Device on page 122 .
Diamond Key	Opens the special character SIP.
Blue Modifier Key	Modifies programmable macro keys allowing for an additional six programmable keys. Press the Blue Modifier key twice to lock the key on and to unlock, press the key once again.
Function Keys	Function keys perform special, custom-defined functions within an application. These keys are accessed by pressing one of the dedicated function keys on the keyboard, or through the appropriate [Blue] key sequence.
Keyboard	Use to enter text.
Bar Codes	
Pairing Bar Code	Pair peripheral Bluetooth scanners to the VC8300.
Unpairing Bar Code	Un-pair peripheral Bluetooth scanners to the VC8300.
Speaker	
Front Speaker	Located on front bezel.

LED Indicators

Table 2 LED Indicators

Indicator	State	Description
Power	Off	The device has no power and cannot be turned on.
	Amber	The device has power and can be turned on.
	Flashing Amber	The unit is pre-heating.
	Solid Green	The unit is ON, operating from external power.
	Slow Flashing Green	The device is running with UPS/Internal Battery power, no external power available.
	Fast Flashing Green	The device is in Sleep mode. Press Power button to wake the device.
Warning	Off	No battery or charger faults.
	Solid Red	Battery temperature is out of range for charging.
	Blinking Red	Any other battery/charging fault, e.g. communication fault, charge timeout, or defective battery pack.

Integrated Keyboard

The device is available with an integrated keyboard in either QWERTY or AZERTY alphanumeric keyboard layout. It features 54 keys, 12 direct function keys, and a power button.

Most of the keys on the keyboard operate much like a desktop computer. Where a key or key function is not consistent with the keyboard, those differences are described in the following sections.

There are a number of modifier keys that provide access to additional keys and system functions.

See [Keyboard Backlight on page 101](#) for information on adjusting the keyboard backlight.

Figure 5 Integrated Keyboard



Getting Started

Table 3 Key Descriptions

Key	Function
Regular Keys	
The Arrow Keys	The arrow keys are located near the bottom of the keyboard, and are represented on the keyboard as triangles pointing in different directions. The keys move the cursor around the screen in the direction of the arrow: up, down, left, and right. The left arrow key should not be confused with the backspace DEL key which is depicted as a left arrow. The cursor is the flashing box or underline character that indicates where the next character you type will appear.
The DEL Key	The DEL key (represented on the keyboard as an arrow pointing left) is the backspace key that moves the cursor one character to the left, erasing the previous key stroke. The [Blue] + DEL keys erase the character at the current cursor position.
The SHIFT Key	The SHIFT key is used to display uppercase alpha characters. ↑ appears in the status bar. Pressing the SHIFT key a second time locks the keys that all alpha characters are uppercase. ↓ appears in the status bar. Press the SHIFT key again to return to the default keypad functions.
The CTRL and ALT Keys	The CTRL and ALT keys modify the function of the next key pressed and are application dependent. C or A appears in the status bar. Pressing the CTRL or ALT key a second time locks the keys. ⌘ or ⌘ appears in the status bar. Press the key again to return to the default keypad functions.
The TAB Key	Typically, the TAB key moves the cursor to the next field to the right or downward.
The ESC Key	Generally, this key is used as a keyboard shortcut to close the current menu, dialog box, or activity.
The SPACE Key	Pressing this key inserts a blank space between characters. In a dialog box, pressing the SPACE key enables or disables a check box.
The INS Key	The INS key inserts a character at the cursor position.
Function Keys	
F1 - F12	Function keys perform special, custom-defined functions within an application. These keys are accessed by pressing one of the dedicated function keys on the keyboard, or through the appropriate [Blue] key sequence. To access the blue function keys, first press the [Blue] key followed by the appropriate function key. Function keys can be used with the operating system or another application.
Programmable Keys	
P1 - P5	The device keyboard is equipped with a series of programmable keys that can be programmed to replace frequently used keystrokes, along with the function of executable keys like the ENTER key, the [BACKSPACE] key, any function key, arrow key, etc.
Special Keys	
Diamond Key	The Diamond key provides access to commonly used symbolic characters. Pressing the key brings up the soft input panel (SIP) on-screen keyboard, with symbols mapped to each key.
Blue Key	The [Blue] key provides access to additional keys. These functions are color coded in blue print on the key caps.

Soft Input Panel

The SIP provides additional commonly used symbolic characters that do not appear on the integrated keyboard. Press the Diamond key to show the SIP. Press the Diamond key a second time to lock the SIP in place. Press the Diamond key a third time to hide the SIP. Press and hold up arrow/down arrow key and slide up and down to re-position the SIP on the screen.

Figure 6 Soft Input Panel

=	+	-	×	÷	()	\	/	~	&	£
[]		{	}	€	?	;	:	#	`	'
↑↓	<	>	_	"	*	^	%	\$	#	!	↑↓

Powering Up the Device

Power up the device after connecting all of the devices.

To power up the device, connect to an appropriate power supply and press the Power button (see [Figure 1 on page 16](#)) or the ignition signal.



CAUTION: Make sure there is a suitable disconnecting device such as a power switch or circuit breaker in the power supply circuit. See [Installing the Device on page 23](#) for more information.

Powering Down the Device

Always shut down the device as follows:

1. Press the Power button until the menu appears on the screen.
2. Touch **Power off**.

Setting Up WLAN

To connect to a WLAN, see [Wireless on page 73](#).

Device Settings

The user can configure the device setting:

- Date and Time settings. See [Setting the Date and Time on page 40](#).
- Display settings, see [Display Settings on page 38](#).
- Sound settings, see [General Sound Setting on page 41](#).

Heater Status

The device offers a unique heater system that enables continuous operations in freezer environments. See [Heater Control on page 49](#) for information about the heater settings.

Installation

Introduction

This chapter provides instructions on installing the device.

Overview

The device can be installed in a variety of ways:

- Position the device horizontally on a desk or mounted on a vehicle console.
- Wall mount the device using the optional wall mount (see [VC8300 Mounting Accessories on page 87](#)).
- Overhead mount on a lift truck cage using mounting hardware.

Depending on the vibration resistance and pivoting demands, mounting brackets, clamp feet or RAM mount elements can also be used to attach the device. Contact your Zebra sales office to find out more about the range of available installation options.



WARNING: The unit could fall during transit or installation/mounting and cause injury. Always ensure that there are two people available when installing or removing the device.

Mounting Instructions

Follow and retain the mounting instructions included with assembly kit when installing the device. See [Safety on page 14](#) for safety instructions.

Installing the Device

Electrical Installation

There are various electrical potentials when installing the unit on a vehicle such as a forklift.

Installation



WARNING: Most electrically driven forklift vehicles have floating chassis connected to neither DC+ or DC-. However, electrical faults can cause the battery + or - to be connected to the chassis via low resistance paths. All connected peripherals must be completely isolated.

The device accepts DC power sources with a minimum of 10 VDC nominal and 48 VDC nominal. A Power Pre-regulator is required for voltages above 48 VDC nominal.

Applying a voltage above 48 VDC nominal without the pre-regulator or reversing polarity may result in permanent damage to the device and voids the product warranty.

Figure 7 Ground Lug

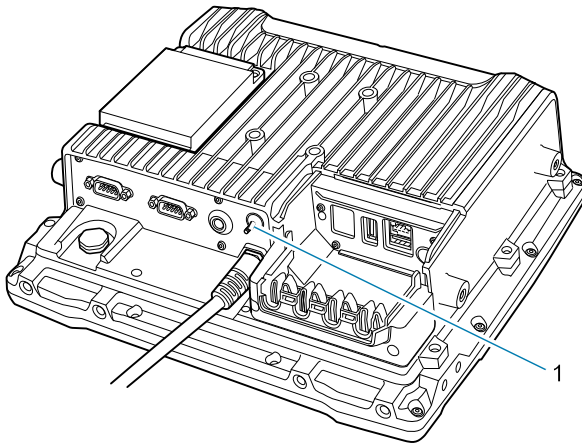

1	Ground lug
---	------------



CAUTION: Attach the device connecting cable as close to the battery as possible. Connecting the device to large electrical loads, such as converters for the forklift motor may result in random restarts, malfunctions and/or irreparable damage to the device.

To connect devices fed by other power sources to the device, such as printers, power up the peripheral devices at the same time or after the device to avoid start-up problems, malfunctions or irreparable damage to the device.

Wiring Guidelines

The metal chassis of the device is equipped with a ground lug (located on the underside adjacent to the power cable) to provide additional ground to the vehicle. It is strongly recommended that a grounding strap is used to connect the ground stud on the vehicle-mount to a solid, reliable contact point on the main portion of the vehicle chassis. It must not be connected to battery negative or terminal block.

As with other vehicle cables, carefully consider the routing of the ground strap to ensure it does not pose a hazard to the operator or the safe operation of the vehicle. If necessary, secure the ground strap with cable ties or some other mechanical means to prevent loops or loose lengths of wire from catching on stationary items when the vehicle is in motion.

Before installing the cables between the mount and other devices, consider the following:

- Ensure that drilling holes do not damage the vehicle or its wiring.
- Protect cable runs from pinching, overheating and physical damage.
- Use grommets to protect cables that pass through metal.

Installation

- Use plastic straps and tie-downs to secure cables and connectors in their desired location, away from areas where they may get snagged or pulled.
- Keep cables away from heat sources, grease, battery acid and other potential hazards.
- Keep cables away from control pedals and other moving parts that may damage the cables or interfere with the operation of the vehicle.



CAUTION: Make sure the cables run inside the roll cage of the vehicle.

If the device is installed in an environment where earth ground is present such as a vehicle with metal wheels running on a metal track, or is powered by the AC/DC adapter in a permanent installation, the ground lug must be connected to the ground structure.

Wiring Vehicle Power to the VC8300



WARNING: Applying voltage above the input voltage rating or reversing polarity may result in permanent damage to the VC8300 and void the product warranty.

An extension power cable is used to wire the VC8300 to the truck battery (order cable separately, see [Accessories on page 84](#)). Wire this cable to a filtered, fused (15A max) accessory supply on the vehicle. Follow the installation instructions supplied with the extension cable.

Additional wiring (minimum 14 gauge), connectors or disconnects used should be rated for at least 300 VDC, 15A.

When connecting the extension power cable:

- If a power extension cable with ignition sense is used, ensure that the ignition sense wires (18AWG wires in red and black leads) and the power wires (14AWG in red and black leads) are reliably secured away from each other, or are separated with reliably secured certified insulation. Minimum 2.8 mm distance, or 0.4 mm distance through insulation is required for the separation.
- The red lead of the 14AWG power cables attach to the vehicles battery positive terminal. The 14AWG black lead connects to the vehicle's battery negative terminal. This should be connected to a proper terminal block and not to the vehicle body. An optional grounding strap wire (sourced separately) may be connected to the ground lug of the VC8300 terminal connector bay and to the vehicle chassis.
- You may have the option to connect power before or after the key switch. Though the VC8300 is equipped with a UPS, a proper shut down is recommended using the Power Off procedure. If it is wired after the key switch, the operator must shut down the VC8300 using the Power Off procedure before turning off the vehicle. If it is wired before the key switch, then to avoid excessive drain on the vehicle battery, either the operator should shut it down when the vehicle is to be left off for an extended period, or the ignition cable shut down wire should be connected and the VC8300 configured to shut down automatically.
- An appropriate fuse type must be used with the power extension cable according to the installation instructions. For main power cable, use 3AB, 15A, 250V, slow blow fuse. For ignition sense input, use 3AB, 0.3A, 250V, slow blow fuse.



NOTE: The VC8300 supports the ignition sense feature that detects when the ignition switch or key switch is On or Off to allow automatic computer start up or shut down (with delay as needed).

When wiring the ignition sense wires (18AWG in red and black), the red 18AWG wire is connected to a positive DC voltage source switched on by the ignition. The black 18AWG wire is connected to ground reference of this switched ignition source.

External Antenna Installation

To install an external antenna:

1. Align the antenna connector with the connector on top of the VC8300.
2. Insert the antenna connector onto the VC8300 connector.
3. Tighten the antenna connector.

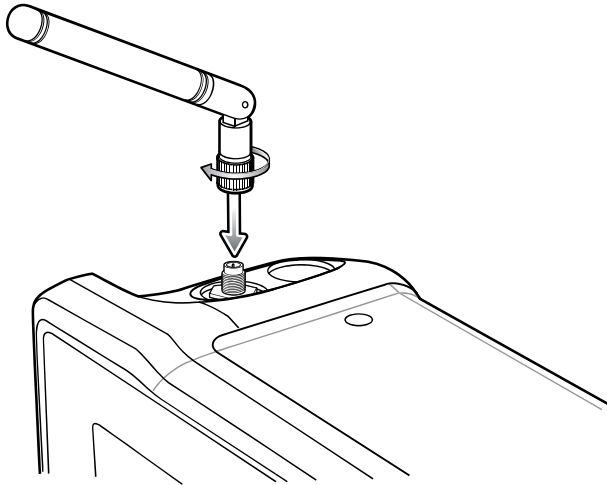

4. Swipe up from the bottom of the Home screen and touch **VC Setting** .
5. Touch **Choose Antenna**.
6. Touch **External Antenna**.
7. Touch Home.

Positioning the VC8300 in the Vehicle

When positioning the VC8300 on the vehicle:

- The driver's field of view must be kept free.
- Plan for sufficient space if a keyboard and scanner are installed with the VC8300.
- No part of the VC8300 system may project beyond the vehicle.

Overview of the Assembly Steps

Before fastening the VC8300 to the vehicle:

- Configure shut down automation.
- Prepare the forklift such as ignition connection and correct voltage.
- It is recommended to fasten the bracket to the vehicle and then install the VC8300 to the bracket.

Cable Dust Cover

For the dust cover location, see [VC8300 Back View with Dust Cover on page 17](#).



CAUTION: Turn on external peripheral devices with their own power supply at the same time or after the VC8300. If this is not possible, ensure that the VC8300 is adequately protected from power leakage caused by an external device.

Strain Relief



CAUTION: For safety reasons, install the supplied cable cover for the external ports prior to using the VC8300.

After the VC8300 and bracket are fastened, prepare the strain relief as follows:

1. Install the cables loosely on the strain relief rail (see [Figure 4 on page 18](#)).
2. As far as possible, route cables leading to or away from the unit next to one another without crossing.
3. Fasten the cables into the strain relief rail precisely at the positions at which the cable openings in the cable cover are located.

Installing the VC8300 on a Forklift



CAUTION: Tighten peripherals with thumbscrews by hand only. Do not use tools for tightening thumbscrews.



NOTE: If installing peripherals, allow enough space when selecting a mounting location.

1. Attach the desired mount to the VC8300. See [VC8300 Mounting Accessories on page 87](#) for detailed mounting options and instructions.
2. Attach the mounted VC8300 to the vehicle and position in a location that does not obstruct the operator's view.
3. If using an external antenna, connect antenna in a vertical position to the VC8300.
4. Connect peripherals to the VC8300. Place the cables in the strain relief brackets inside the dust cover and replace the dust cover (see [Figure 3 on page 17](#)).
5. Connect the VC8300 to the vehicle DC supply.
6. Press the **Power** button to turn the device On or Off (see [Figure 2 on page 17](#)).

Figure 8 View Obstruction Considerations

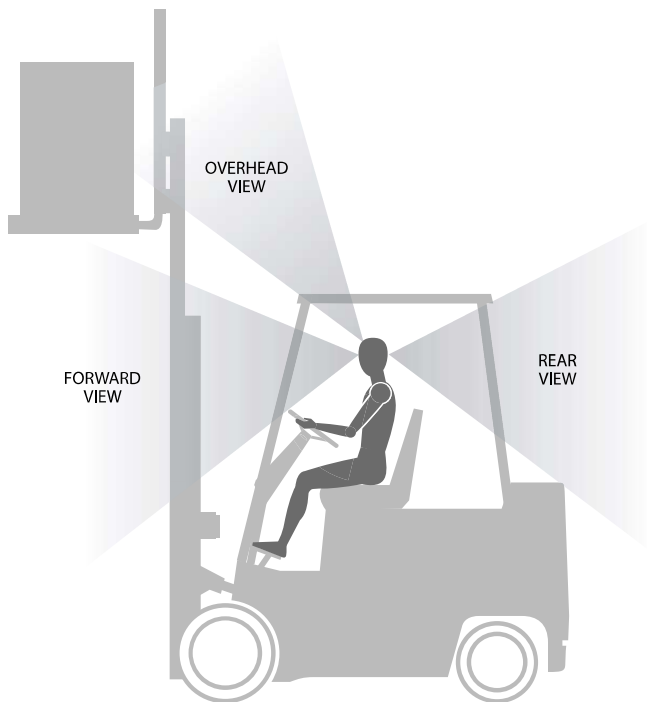

Forklift Battery Replacement Conditions

The VC8300 maintains normal function of applications and connections during and after forklift battery replacement.

Replace the forklift battery at any point during a shift and/or while the VC8300 is fully running.

The forklift battery may be replaced under following condition: VC8300 external temperature range: -30°C to $+50^{\circ}\text{C}$ (-22°F to 122°F).

During forklift battery replacement (VC8300 is running on UPS battery), both Android and the VC8300 are monitoring remaining UPS battery capacity. The default Low Battery notification threshold is set to 30%. The Critical Battery threshold is set to 7%. If UPS battery is discharged below 7%, the VC8300 automatically shuts down.

Starting from Cold Soak

The VC8300 can start up from a saturated cold soak at -30°C (or above) internal VC8300 temperature when a valid external DC power source is present.

The VC8300 design minimizes wait time from -30°C cold soak to load the OS and have internal heaters to assist system warm up.

From a -30°C cold soak condition, the VC8300 battery heater may be activated to warm the UPS battery to an acceptable charging temperature if charging is needed. The conditions and time to heat the battery are managed by the system. The OS load time and VC8300 ready for use time is independent of warming the battery.

Pre-Heat Mode

When the device is powered down or suspended and the system temperature is below -25°C (-13°F), the device enters pre-heat mode when the user presses the power key. This warms up critical internal components with the heater elements prior to boot up.

When in Pre-heat mode the Power LED blinks amber.

The pre-heat mode lasts no longer than 15 minutes. The freezer configuration spends less time in Pre-heat mode due to the additional Touch Panel heater.

The device remains powered down or suspended during Pre-heat mode. Once the system reaches the adequate temperature, the device automatically boots up. The user is not required to press the power button.

The device does not enter Pre-heat mode if it is outside the operating temperature range (-30°C to 50°C (-22°F to 122°F)).

Installing the Power Pre-Regulator



IMPORTANT: The Zebra power extension cable positive lead is red and the negative lead is black.

It is recommended that all connections be secured with electrical tape or heat shrink to prevent contaminants from degrading the connection.

To install the power pre-regulator:

1. Attach the pre-regulator cable male connector to the Zebra power extension cable which is installed on the vehicle.
2. Connect the pre-regulator cable female connector either directly to the VC8300 power cable, or to the power extension cable. See [Figure 9](#).

Installation

Figure 9 Connections To Vehicle DC Supply

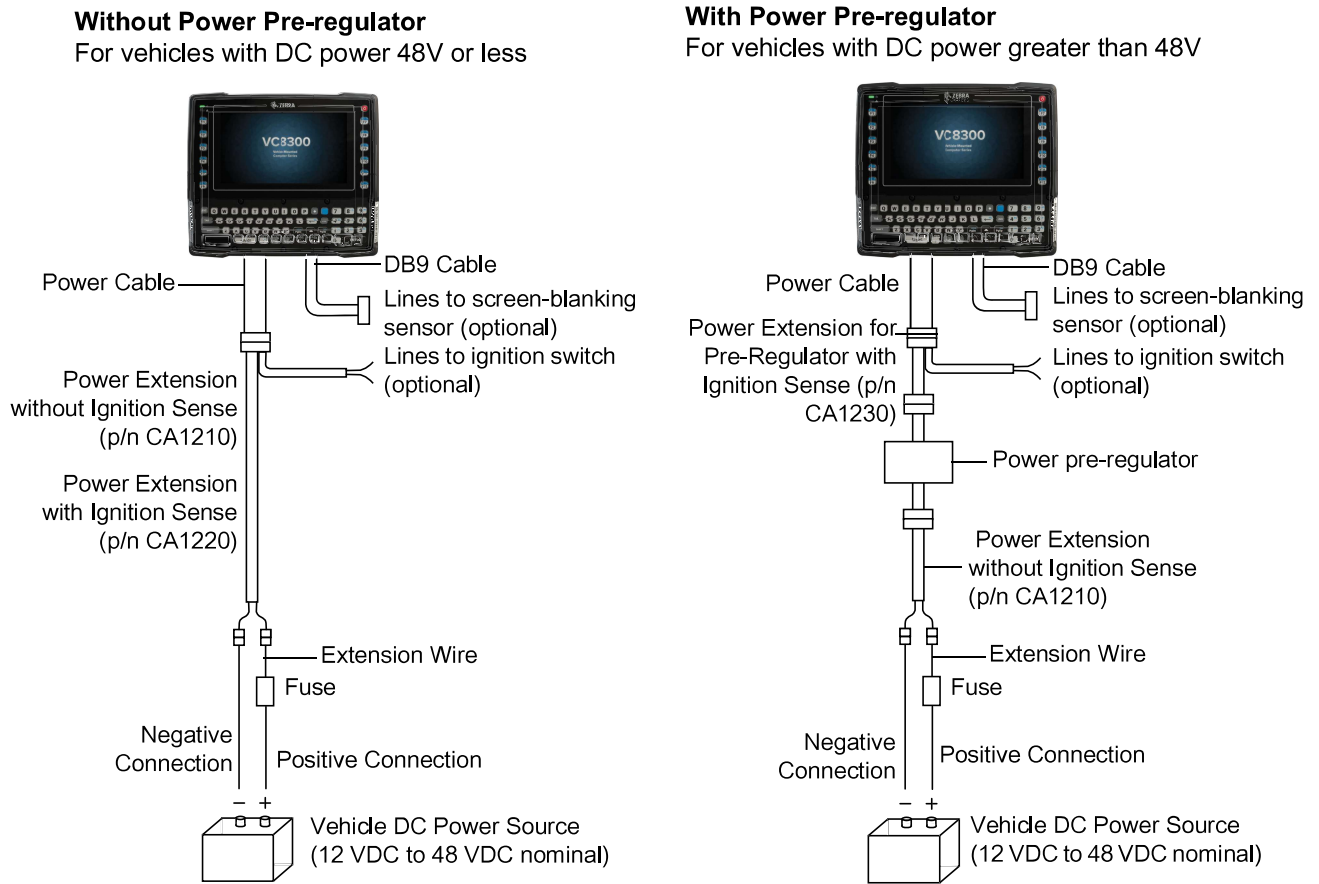

Non-Vehicle Installations

Using AC power, the VC8300 Vehicle-Mount Computer can be mounted at fixed locations adjacent to cross-dock doors, manufacturing stations, or in offices.

Use the 100/240 VAC Power Supply (p/n PS1450) to power the computer from an AC source.

IMPORTANT: The AC/DC power supply is only intended for use at room temperature condition such as an office environment.

Power On/Off with Ignition

The VC8300 is equipped with an ignition sense feature which shuts down the VC8300 when the vehicle ignition is turned off and can power on the VC8300 when the ignition is switched on. To use this feature, a power extension cable with ignition sense wires must be used and installed properly on the vehicle.

The cable in [Figure 10](#) is the power extension cable (p/n CA1220) with two wires used to connect to vehicle ignition. The red and black leads of the two 18AWG wires that connect to the key switch of the ignition and ground, respectively. Once the wires are connected, the VC8300 may switch on or off depending on the state of the vehicle ignition key. See [VC Settings on page 56](#) to select power settings.



IMPORTANT: When connecting to an ignition switch using the power extension cable with ignition sense wires, ensure that the wires of different polarities are reliably secured away from each other, or are separated with reliably secured certified insulation. A minimum distance of 2.8mm (or 0.4mm distance through insulation) is required for the separation.

The thinner wires (18 AWG) are used for Ignition Sense wires while the thicker wires (14AWG) are used for Vehicle Power and Ground. Identify them carefully and **Do Not** confuse them.

An appropriate fuse type must be used with the power extension cable according to the installation instructions. For the main power cable, use 3AB, 15A, 250V, slow blow fuse. For ignition sense input, use 3AB, 0.3A, 250V, slow blow fuse.

Figure 10 Power Extension Cable Kit with Optional Ignition Sense Wires (p/n CA1220)

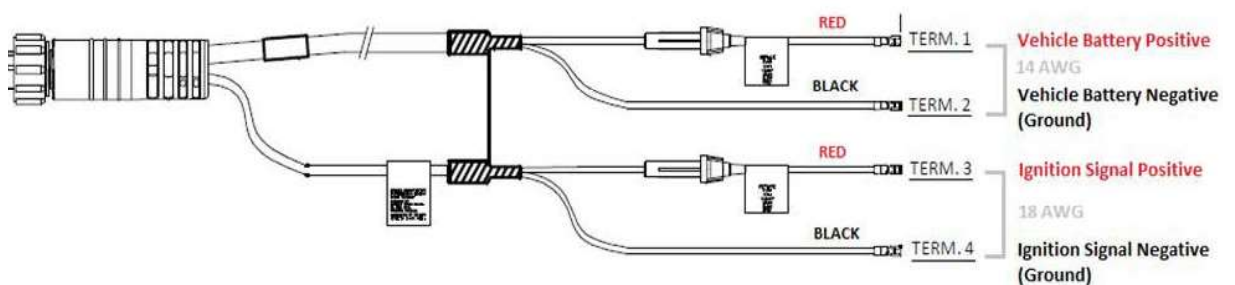

Screen Blanking Wiring

Connecting Switch for Screen Blanking

To use Screen Blanking, connect one of the two DB9 serial ports (using CA1300 Screen Blanking cable) on the VC8300 to a switch. Activate this switch electrically (e.g. motion sensor) or mechanically (e.g. pedal switch) when the vehicle is in motion.

Figure 11 Connecting the Switch to the DB9 Cable

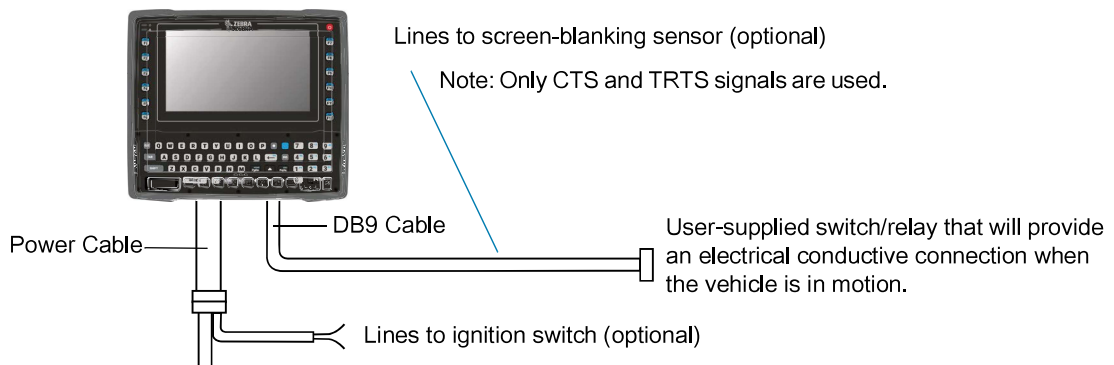



IMPORTANT: For customers migrating to the VC8300 from a 8515, 8525, 8535 vehicle mount computer or a 753x hand-held computer cradle:

If the screen blanking feature was used previously, ensure that you are no longer feeding the screen blanking signals to the VC8300 main DC power cable. Rewire the screen blanking inputs to the VC8300 DB-9 serial port through the DB-9 screen blanking cable. In previous generations of vehicle-mount computers, the screen blanking signals were fed in to the terminal through 2 of the 4 wires in the CPC connector of the DC power cable. This no longer applies for the VC830000.

The screen blanking feature makes use of either one of the DB-9 ports to monitor electrical relay closure. When enabled, the CTS/RTS pins of the DB9 port are continuously monitored by the screen blanking application. See [Figure 12](#) for pin configuration.

When the vehicle is in motion, the switch closes the circuit, allowing data packets to be sent or received through the RTS and CTS pins. The computer detects that the circuit is closed and turns off the screen.

When the vehicle is not in motion, the switch opens the circuit, preventing data packets from being sent or received. The computer detects that the circuit is open and turns on the screen.

Figure 12 Screen Blanking DB9 Pin Configuration

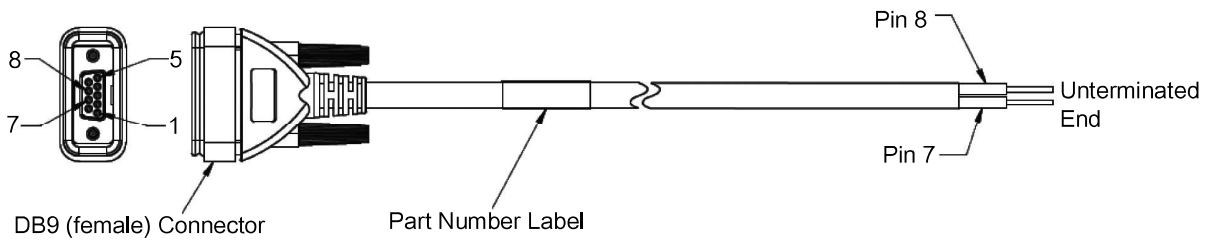

Using the Device

Home Screen

Turn on the device to display the Home screen. Depending on how your system administrator configured your device, your Home screen may appear differently than the graphics in this section.

After a suspend or screen time-out, the Home screen displays with the lock slider. Touch the screen and slide up to unlock.

The Home screen provides four additional screens to place widgets and shortcuts. Swipe the screen left or right to view the additional screens.



NOTE: By default, AOSP devices do not have the same icons on the Home screen as GMS devices. Icons are shown below for example only.

Home screen icons can be configured by the user and may look different than shown.

Figure 13 Home Screen

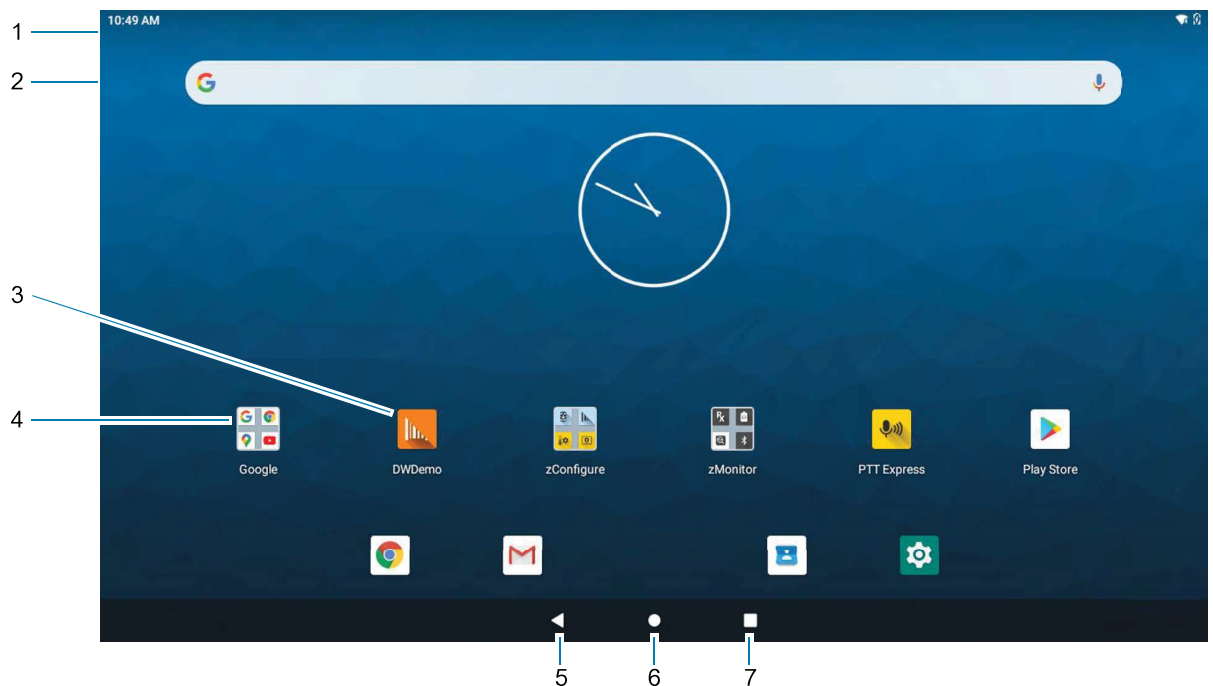

1	Status Bar	Displays the time, status icons (right side), and notification icons (left side). For more information see Notification Icons on page 35 and Managing Notifications on page 37 .
2	Widgets	Launches stand-alone apps that run on the Home screen.
3	Shortcut Icons	Opens apps installed on the device.
4	Folder	Contains apps.
5	Back	Displays the previous screen.
6	Home	Displays the Home screen.
7	Recent	Displays recently used applications.

Setting Home Screen Rotation

By default, the Home screen rotation is disabled.

1. Touch and hold anywhere on the Home screen until the options appear.
2. Touch **Home settings**.
3. Touch the **Allow Home screen rotation** switch.
4. Touch the Home button.
5. Rotate the device.

Status Bar

The Status bar displays the time, notification icons (left side), and status icons (right side).

If there are more notifications than can fit in the Status bar, a dot displays indicating that more notifications exist. Swipe down from the Status bar to open the Notification panel and view all notifications and status.

Figure 14 Notification and Status Icons





















1	Notification Icons. See Notification Icons on page 35 .
2	Status Icons. See Status Icons on page 36 .

Notification Icons

Notification icons indicate app events and messages.





















Table 4 Notification Icons

Icon	Description
	UPS battery is low.
	More notifications are available for viewing.
	Data is syncing.
	Indicates an upcoming event. AOSP devices only.
	Indicates an upcoming event. GMS devices only.
	Open Wi-Fi network is available.
	Audio is playing.
	Problem with sign-in or sync has occurred.
	Device is uploading data.
	Animated: the device is downloading data. Static: the download is complete.
	Device is connected to or disconnected from a virtual private network (VPN).
	Preparing internal storage by checking it for errors.
	USB debugging is enabled on the device.
	Wired headset with a boom module is connected to the device.
	Wired headset without a boom module is connected to the device.
	PTT Express Voice client status. See the PTT Express PTT Notification Icons for a complete list.
	Indicates the RxLogger app is running.
	Indicates the Bluetooth scanner is connected to the device.
	Indicates the ring scanner is connected to the device in HID mode.

Status Icons

Status icons display system information for the device.

Table 5 Status Icons

Icon	Description
	Alarm is active.
	UPS battery is fully charged.
	UPS battery is partially drained.
	UPS battery charge is low.
	UPS battery charge is very low.
	UPS battery is charging.
	All sounds, except media and alarms, are muted. Vibrate mode is active.
	Do Not Disturb mode active.
	Airplane Mode is active. All radios are turned off.
	Bluetooth is on.
	The device is connected to a Bluetooth device.
	Connected to a Wi-Fi network. Indicates the Wi-Fi version number.
	Not connected to a Wi-Fi network or no Wi-Fi signal.
	Connected to an Ethernet network.
	Speakerphone enabled.
	Indicates that the Blue key is pressed.
	Indicates that the Blue key is locked.
	Indicates that the ALT key is pressed.
	Indicates that the CTRL key is pressed.
	Indicates that the Shift key is pressed.
	Indicates that the Shift key is locked.

Managing Notifications

Notification icons report the arrival of new messages, calendar events, alarms, and ongoing events. When a notification occurs, an icon appears in the Status bar with a brief description. See [Notification Icons on page 35](#) for a list of possible notification icons and their description.

- To view a list of all notifications, open the Notification panel by dragging the Status bar down from the top of the screen.

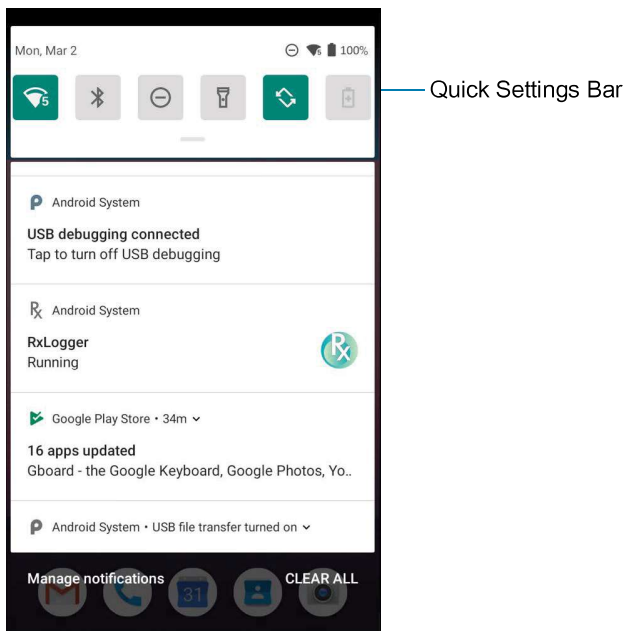

- To respond to a notification, open the Notification panel and then touch a notification. The Notification panel closes and the corresponding app opens.
- To manage recent or frequently used notifications, open the Notification panel and then touch **Manage notifications**. Touch the toggle switch next to an app to turn off all notifications, or touch an app for more notification options.
- To clear all notifications, open the Notification panel and then touch **CLEAR ALL**. All event-based notifications are removed. Ongoing notifications remain in the list.
- To close the Notification panel, swipe the Notification panel up.

Opening the Quick Access Panel

Use the Quick Access panel to access frequently used settings (for example, Airplane mode). To get to the Quick Access Panel:

- If the device is locked, swipe down once.
- If the device is unlocked, swipe down once with two fingers, or twice with one finger.

- If the Notification panel is open, swipe down from the Quick Settings bar.

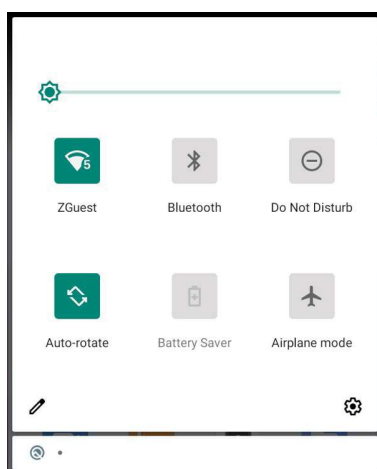

NOTE: Not all icons are pictured. Icons may vary.

Quick Access Panel Icons

- Display brightness - Use the slider to decrease or increase the brightness of the screen.
- Wi-Fi network - Turn Wi-Fi on or off. To open Wi-Fi settings, touch the Wi-Fi network name.
- Bluetooth settings - Turn Bluetooth on or off. To open Bluetooth settings, touch **Bluetooth**.
- Battery saver - (not applicable).
- Invert colors - Invert the display colors.
- Do not disturb - Control how and when to receive notifications.
- Airplane mode - Turn Airplane mode on or off. When Airplane mode is on the device does not connect to Wi-Fi or Bluetooth.
- Auto-rotate - Lock the device's orientation in portrait or landscape mode or set to automatically rotate.
- Screen Cast - Share phone content on Chromecast or a television with Google Cast built-in. Touch cast screen to display a list of devices, then touch a device to begin casting.
- Dark Theme - Toggles dark theme on and off. Dark themes reduce the luminance emitted by the screen, while meeting minimum color contrast ratios. It helps improve visual ergonomics by reducing eye strain, adjusting brightness to current lighting conditions, and facilitating screen use in dark environments, while conserving battery power.
- Focus mode - Turn on to pause distracting apps. To open Focus mode settings, touch and hold.
- Bedtime mode - Turn grayscale on and off. Grayscale turns the screen black and white, reducing phone distractions and improving battery life.
- Nearby Share - Helps find and interact with services and devices close to the device.

Editing Icons on the Quick Settings Bar

The first several setting tiles from the Quick Access panel become the Quick Settings bar.

Open the Quick Access panel and touch  to edit, add, or remove settings tiles.

Battery Management

To check the charge status of the backup battery, open **Settings** and touch **System > About phone > Battery Information** or touch **About phone > Status**.

Battery status indicates that the battery is discharging and **Battery level** lists the battery charge (as a percentage of fully charged).

Monitoring Battery Usage

The **Battery** screen provides battery charge details and power management options to extend battery life.

1. Go to **Settings**.
2. Touch **Battery**.

Display battery information and power management options for a specific app.

1. Go to **Settings**.
2. Touch **Apps & notifications**.
3. Touch an app.
4. Touch **Advanced > Battery**.

Different apps display different information. Some apps include buttons that open screens with settings to adjust power use. Use the **DISABLE** or **FORCE STOP** buttons to turn off apps that consume too much power.

Low Battery Notification

When the battery charge level drops below 30%, the device displays a notice to connect the device to power. The user should charge the battery using one of the charging accessories.

When the battery charge drops below 15%, the device displays a notice to connect the device to power. The user must charge the battery using one of the charging accessories.

When the battery charge drops below 7%, the device turns off. The user must charge the battery using one of the charging accessories.

Waking the Device

The device goes into Suspend mode when you press the Power button or after a period of inactivity (set in the Display settings window).

1. To wake the device from Suspend mode, press the Power button.

The Lock screen displays.

2. Swipe the screen up to unlock.
 - If the Pattern screen unlock feature is enabled, the Pattern screen appears instead of the Lock screen.
 - If the PIN or Password screen unlock feature is enabled, enter the PIN or password after unlocking the screen.



NOTE: If you enter the PIN, password, or pattern incorrectly five times, you must wait 30 seconds before trying again.

If you forget the PIN, password, or pattern contact your system administrator.

USB Communication

Connect the device to a host computer to transfer files between the device and the host computer.

When connecting the device to a host computer, follow the host computer's instructions for connecting and disconnecting USB devices, to avoid damaging or corrupting files. For information on USB communication accessories available for this device, see Accessories.

Transferring Files

Use Transfer files to copy files between the device and the host computer.

1. Connect the device to a host computer using a USB accessory.
2. On the device, pull down the Notification panel and touch **Charging this device via USB**.
By default, **No data transfer** is selected.
3. Touch **File Transfer**.
4. On the host computer, open a file explorer application.
5. Locate the **device** as a portable device.
6. Open the **Internal storage** folder.
7. Copy files to and from the device or delete files as required.

Transferring Photos

Use **PTP** to copy photos from the device to the host computer.

1. Connect the device to a host computer using a USB accessory.
2. On the device, pull down the Notification panel and touch **Charging this device via USB**.
3. Touch **PTP**.
4. On the host computer, open a file explorer application.
5. Open the **Internal storage** folder.
6. Copy or delete photos as required.

Disconnect from the Host Computer



CAUTION: Carefully follow the host computer's instructions to disconnect USB devices correctly to avoid losing information.

To disconnect the device from the host computer:

1. On the host computer, unmount the device.
2. Remove the device from the USB accessory.

Transferring Files

To transfer files to the device use a USB drive.

Using a USB Drive



NOTE: Use Media Transfer Protocol (MTP) to copy files between the device (internal memory) and a USB drive.

1. Remove the dust cover on the back of the device.
2. Plug the USB drive into the USB port on the bottom of the device. A notification appears indicating that the device detected the USB drive.



NOTE: Alternately, the **General USB drive** notification touch the down arrow next to **Android System** and then touch **Explore** to open **Files** app.

3. Open **Files**.
4. Touch **General USB Drive** on the left menu to display the contents of the USB drive.
5. Use **Files** to copy files between the drive and the device.

Disconnecting USB Drive

To remove the USB drive:









1. Swipe down from the status bar.
2. In the **General USB drive** notification, touch the down arrow next to **Android System** and then touch **EJECT**.
3. Remove the USB drive from the device.
4. Replace the dust cover.

Applications

The **APPS** screen displays icons for all installed apps. See Application Deployment for information on installing and uninstalling apps. For information on standard Android apps, go to the Google Play [Apps store](#).











The following table describes the apps installed on the device.

Table 6 Apps

Icon	Description
	Battery Manager - Displays battery information, including charge level, status, health and wear level.
	Bluetooth Pairing Utility – Use to pair a Zebra Bluetooth scanner with the device by scanning a barcode.
	Calculator - Provides the basic and scientific arithmetic functions.
	Calendar - Use to manage events and appointments. GMS/GMS-Restricted only.
	Calendar - Use to manage events and appointments. AOSP only.
	Chrome - Use to access the Internet or intranet. GMS/GMS-Restricted only.
	Chromium - Use to access the Internet or intranet. AOSP only.
	Clock - Use to schedule alarms for appointments or as a wake-up.
	Contacts - Use to manage contact information.

Applications

Table 6 Apps (Continued)

Icon	Description
	DataWedge - Enables data capture using the imager. For more information, see DataWedge Demonstration on page 47 .
	DisplayLink Presenter - Use to present the device screen onto a connected monitor.
	Drive - Upload photos, videos, documents, and other files to personal storage site. GMS/GMS-Restricted only.
	DWDemo - Provides a way to demonstrate the data capture features using the imager. For more information, see DataWedge Demonstration on page 47 .
	Email - Use to send and receive email. AOSP only.
	Files - Organize and manage files on the device.
	Gallery - Use to view photos stored on the internal. AOSP only.
	Gmail - Use to send and receive email using a Google email account. GMS/GMS-Restricted only.
	Google - Launches Google™ search app. GMS/GMS-Restricted only.
	Heater Control - Use to enable heaters when using the device in cold environments. See Heater Control.
	Keep Notes - Use to create, edit, and share notes. GMS/GMS-Restricted only.
	License Manager - Use to manage software licenses on the device.
	Maps - Use to see your location on a map (with public transit, traffic, or satellite overlays). Search for any business or place of interest. Provides turn-by-turn navigation with voice guidance, traffic-avoidance, and alternate routes, for drivers, cyclists, walkers, and users of public transportation. GMS/GMS-Restricted only.
	Music - Play music stored on the internal storage. AOSP only.

Applications

Table 6 Apps (Continued)



















Icon	Description
	Music - Play music stored on the internal storage. AOSP only.
	Photos - Use to sync photos with Google account. GMS/GMS-Restricted only.
	Play Movies & TV - View movies and video on your device. GMS/GMS-Restricted only.
	Play Store - Download music, movies, books, and Android apps and games from the Google Play Store. GMS/GMS-Restricted only.
	PTT Express - Use to launch PTT Express client for VoIP communication.
	RxLogger - Use to diagnose device and app issues. For more information, see RxLogger on page 53 .
	Search - Use to search the Web. Requires an Internet connection. AOSP only.
	Settings - Use to configure the device.
	StageNow - Allows the device to stage a device for initial use by initiating the deployment of settings, firmware, and software.
	VC Settings - Use to control settings for the device. See VC Settings on page 55 .
	Velocity - Opens the Ivanti (formerly Wavelink) terminal emulation app.
	Videos - Use to view videos on the device. AOSP only.
	Voice Search - Use to perform searches by asking questions. GMS/GMS-Restricted only.
	Worry Free Wifi Analyzer - A diagnostic intelligent app. Use to diagnose surrounding area and display network stats, such as coverage hole detection, or AP in vicinity. Refer to the Worry Free Wi-Fi Analyzer Administrator Guide for Android.

Table 6 Apps (Continued)

Icon	Description
	YouTube - Use to view videos on the YouTube™ web site. GMS/GMS-Restricted only.
	YT Music - Use to listen to music. GMS/GMS-Restricted only.
	Zebra Bluetooth Settings - Use to configure Bluetooth logging.
	Zebra Data Services - Use to enable or disable Zebra Data Services. Some options are set by the system administrator.

Accessing Apps

All apps installed on the device are accessed using the **APPS** window.

1. On the Home screen, swipe up from the bottom of the screen.
2. Slide the **APPS** window up or down to view more app icons.
3. Touch an icon to open the app.

Switching Between Recent Apps

Use the Recent button to switch between recently used apps.

1. Touch Recent button.
 - A window appears on the screen with icons of recently used apps.
2. Slide the apps displayed up and down to view all recently used apps.
3. Swipe left or right to remove app from the list and force close the app.
4. Touch an icon to open an app or touch Back button to return to the current screen.

Battery Manager

The **Battery Manager** provides detailed information about the battery and battery swap procedures on supported devices.



Opening Battery Manager

To open the Battery Manager app, swipe up from the bottom of the Home screen, and then touch .

Battery Manager Information Tab

The Battery Manager displays detailed information about battery charging, health, and status.

Table 7 Battery Icon Description

Battery Icon	Description
	Battery charge level is between 85% and 100%.
	Battery charge level is between 19% and 84%.
	Battery charge level is between 0% and 18%.

- **Level** - The current battery charge level as a percentage. Displays **-%** when level is unknown.
- **Wear** - The health of the battery in graphical form. When the wear level exceeds 80%, the bar color changes to red.
- **Health** - The health of the battery. If a critical error occurs,  appears. Touch to view the error description.
 - **Decommission** - The battery is past its useful life and should be replaced. See system administrator.
 - **Good** - The battery is good.
 - **Charge error** - An error occurred while charging. See system administrator.
 - **Over Current** - An over-current condition occurred. See system administrator.
 - **Dead** - The battery has no charge. Replace the battery.
 - **Over Voltage** - An over-voltage condition occurred. See system administrator.
 - **Below Temperature** - The battery temperature is below the operating temperature. See system administrator.
 - **Failure Detected** - A failure has been detected in the battery. See system administrator.
 - **Unknown** - See system administrator.
- **Charge Status**
 - **Not charging** - The device is not connected to AC power.
 - **Charging-AC** - The device is connected to AC power and charging.
 - **Charging-USB** - The device is connected to a host computer with a USB cable and charging.
 - **Discharging** - The battery is discharging.
 - **Full** - That the battery is fully charged.
 - **Unknown** - The battery status is unknown.
- **Time until Full** - The amount of time until the battery is fully charged.
- **Time since charging** - The amount of time since the device began charging.
- **Time until empty** - The amount of time until the battery is empty.
- **Advanced info** - Touch to view additional battery information.
 - **Battery present status** - Indicates that the battery is present.

Applications

- **Battery level** - The battery charge level as a percentage of scale.
- **Battery scale** - The battery scale level used to determine battery level (100).
- **Battery voltage** - The current battery voltage in millivolts.
- **Battery temperature** - The current battery temperature in degrees Centigrade.
- **Battery technology** - The type of battery.
- **Battery current** - The average current into or out of the battery over the last second in mAh.
- **Battery manufacture date** - The date of manufacture.
- **Battery serial number** - The battery serial number. The number matches the serial number printed on the battery label.
- **Battery part number** - The battery part number.
- **Battery decommission status** - Indicates if the battery is past its life span.
 - **Battery Good** - The battery is in good health.
 - **Decommissioned Battery** - The battery is past its useful life and should be replaced.
- **Base cumulative charge** - Cumulative charge using Zebra charging equipment only.
- **Battery present capacity** - Maximum amount of charge that could be pulled from the battery under the present discharge conditions if the battery were fully charged.
- **Battery health percentage** - With a range from **0** to **100**, this is the ratio of “present_capacity” to “design_capacity” at a discharge rate of “design_capacity”.
- **% decommission threshold** - The default % decommission threshold for a gifted battery as 80%.
- **Battery present charge** - Amount of usable charge remaining in the battery at present under the current discharge conditions.
- **Battery total cumulative charge** - The total accumulated charge in all chargers.
- **Battery error status** - The error status of the battery.
- **App version** - The application version number.









DataWedge Demonstration

Use **DataWedge Demonstration** to demonstrate data capture functionality. To configure DataWedge, refer to techdocs.zebra.com/datawedge/.



NOTE: DataWedge is enabled on the Home screen. To disable this feature, go to the DataWedge settings and disable the **Launcher** profile.

Table 8 DataWedge Demonstration Icons

	Icon	Description
Illumination		Imager illumination is on. Touch to turn illumination off.
		Imager illumination is off. Touch to turn illumination on.
Data Capture		Indicates a USB scanner is connected to the device.
		Indicates a USB scanner is not connected to the device.
		A Bluetooth scanner is connected.
		A Bluetooth scanner is not connected.
Scan Mode		Imager is in picklist mode. Touch to change to normal scan mode.
		Imager is in normal scan mode. Touch to change to picklist mode.
Menu		Opens a menu to view the application information or to set the application DataWedge profile.

Scanner Selection

To select a scanner, touch  > **Settings** > **Scanner selection**.

See the Data Capture section for more information.

Press the scanner trigger button or touch the on-screen yellow scan button to capture data. The data appears in the text field below the yellow button.

Heater Control



IMPORTANT: Heater Control app is only applicable to freezer configurations.

The device heater ensures optimum performance in freezers. The heater benefits include:

- Touch screen heater clears condensation on the display.
- Port heater prevents condensation on contacts.
- UPS Battery requires a heater to operate below freezing temperatures.
- The user interface displays current temperatures.

Temperatures

The **Status** tab displays the current temperature for the following:

- Serial Ports
- USB Ports
- Battery
- Keyboard
- Touch Panel (Freeze configurations only)
- Ambient.

Serial Port Heater

Use the **Serial Ports Heater** tab to enable and set the heater for the serial ports.

- **Enable Heater** - Turns on or off the serial port heater. When on, the switch turn red.
- **Heater on threshold** - Set the temperature at which the heater turns on (default - 5°C/41°F).
- **Heater off threshold** - Set the temperature at which the heater turns off (default - 15°C/59°F).

USB Port Heater

Use the **USB Ports Heater** tab to enable and set the heater for the USB ports.

- **Enable Heater** - Turns on or off the USB port heater. When on, the switch turn red.
- **Heater on threshold** - Set the temperature at which the heater turns on (default - 5°C/41°F).
- **Heater off threshold** - Set the temperature at which the heater turns off (default - 15°C/59°F).

Battery Heater

Use the **Battery Heater** tab to enable and set the heater for the battery.

- **Enable Heater** - Turns on or off the battery heater. When on, the switch turn red.
- **Heater on threshold** - Set the temperature at which the heater turns on (default - 15°C/59°F).
- **Heater off threshold** - Set the temperature at which the heater turns off (default - 20°C/68°F).

Touch Panel Heater



NOTE: Touch Panel Heater tab is available on Freezer configurations only.

Use the **Touch Panel Heater** tab to enable and set the heater for the touch panel.

- **Enable Heater** - Turns on or off the touch panel heater. When on, the switch turn red.
- **Heater on threshold** - Set the temperature at which the heater turns on (default - 15°C/59°F).
- **Heater off threshold** - Set the temperature at which the heater turns off (default - 22°C/72°F).

Keyboard Heater

Use the **Keyboard Heater** tab to enable and set the heater for the keyboard.

- **Enable Heater** - Turns on or off the keyboard heater. When on, the switch turn red.
- **Heater on threshold** - Set the temperature at which the heater turns on (default - 15°C/59°F).
- **Heater off threshold** - Set the temperature at which the heater turns off (default - 22°C/72°F).

PTT Express Voice Client



NOTE: Requires a PTT Express License.



IMPORTANT: The optional M1000 Speaker/Microphone is required to use PTT Express on the VC8300.

PTT Express Voice Client enables Push-To-Talk (PTT) communication between disparate enterprise devices. Leveraging existing Wireless Local Area Network (WLAN) infrastructure, PTT Express delivers simple PTT communication without requiring a voice communication server.

- **Group Call:** Press and hold the PTT (Talk) button to start communicating with other voice client users.
- **Private Response:** Double-press the PTT button to respond to the originator of the last broadcast or to make a Private Response.

Refer to the PTT Express User Guide at zebra.com/support for information on configuring the PTT Express Client application.

Speaker/Microphone Setup

Use the optional M1000 Speaker/Microphone to use PTT Express:

1. Remove the dust cover on the back of the VC8300.
2. Plug the Speaker/microphone audio plug into the Speaker/Mic jack.
3. Replace the audio cable into the cable strain relief.
4. Replace the dust cover.

PTT Audible Indicators

The following tones provide helpful cues when using the voice client.







Applications

- **Talk Tone:** Double chirp. Plays when the Talk button is depressed. This is a prompt for you to start talking.
- **Access Tone:** Single beep. Plays when another user just finished a broadcast or response. You can now initiate a Group Broadcast or Private Response.
- **Busy Tone:** Continuous tone. Plays when the Talk button is depressed and another user is already communicating on the same talkgroup. Plays after the maximum allowed talk time is reached (60 seconds).
- **Network Tone:**
 - Three increasing pitch beeps. Plays when PTT Express acquires the WLAN connection and the service is enabled.
 - Three decreasing pitch beeps. Plays when PTT Express loses the WLAN connection or the service is disabled.

PTT Notification Icons

Notification icons indicate the current state of the PTT Express Voice client.

Table 9 PTT Express Icon Descriptions

Status Icon	Description
	The PTT Express Voice client is disabled.
	The PTT Express Voice client is enabled but not connected to a WLAN.
	The PTT Express Voice client is enabled, connected to a WLAN, and listening on the Talk Group indicated by the number next to the icon.
	The PTT Express Voice client is enabled, connected to a WLAN, and communicating on the Talk Group indicated by the number next to the icon.
	The PTT Express Voice client is enabled, connected to a WLAN, and in a private response.
	The PTT Express Voice client is enabled and muted.
	The PTT Express Voice client is enabled but it is not able to communicate due to a VoIP telephony call in progress.

Enabling PTT Communication

1. Swipe up from the bottom of the Home screen and touch .
2. Slide the **Enable/Disable Switch** to the **ON** position. The button changes to **ON**.

Selecting a Talk Group

One of 32 Talk Groups can be selected by PTT Express users. However, only one talk group may be enabled at a time on the device. Touch one of the 32 Talk Groups. The selected Talk Group is highlighted.

PTT Communication



NOTE: This section describes the default PTT Express client configuration. Refer to the PTT Express V1.2 User Guide for detailed information on using the client.

All calls are initiated using the Talk button.

Creating a Group Call

1. Press and hold the PTT button (or the Talk button on the headset) and listen for the talk tone.
If you hear a busy tone, release the button and wait a moment before making another attempt. Ensure that PTT Express and the WLAN are enabled.
2. Start talking after hearing the talk tone.



NOTE: Holding the button for more than 60 seconds (default) drops the call, allowing others to make Group calls. Release the button when finished talking to allow others to make calls.

3. Release the button when finished talking.

Responding with a Private Response

The Private Response can only be initiated once a Group Call has been established. The initial Private Response is made to the originator of the Group Call.

1. Wait for an access tone.
2. Within 10 seconds, double-press the PTT button, and listen for the talk tone.
3. If you hear a busy tone, release the button and wait a moment before making another attempt. Ensure that PTT Express and the WLAN are enabled.
4. Start talking after the talk tone plays.
5. Release the button when finished talking.

Disabling PTT Communication

1. Swipe up from the bottom of the Home screen and touch .
2. Slide the **Enable/Disable Switch** to the **OFF** position. The button changes to **OFF**.
3. Touch the Home button.

RxLogger

RxLogger is a comprehensive diagnostic tool that provides application and system metrics, and diagnoses device and application issues. RxLogger logs the following information: CPU load, memory load, memory snapshots, battery consumption, power states, wireless logging, cellular logging, TCP dumps, Bluetooth logging, GPS logging, logcat, FTP push/pull, ANR dumps, etc. All generated logs and files are saved onto flash storage on the device (internal or external).

RxLogger Configuration

RxLogger is built with an extensible plug-in architecture and comes packaged with a number of plug-ins already built-in. For information on configuring RxLogger, refer to techdocs.zebra.com/rxlogger/.

To open the configuration screen, from the RxLogger home screen touch **Settings**.

Configuration File

RxLogger configuration can be set using an XML file. The **config.xml** configuration file is located in the **RxLogger\config** folder. Copy the file from the device to a host computer using a USB connection. Edit the configuration file and then replace the XML file on the device. There is no need to stop and restart the RxLogger service since the file change is automatically detected.

Enabling Logging

To enable logging:

1. Swipe the screen up and select .
2. Touch **Start**.
3. Touch the Home button.

Disabling Logging

To disable logging:

1. Swipe the screen up and select .
2. Touch **Stop**.
3. Touch the Home button.

Extracting Log Files

1. Connect the device to a host computer using an USB connection.
2. Using a file explorer, navigate to the **RxLogger** folder.
3. Copy the file from the device to the host computer.
4. Disconnect the device from the host computer.

Backing Up

RxLogger Utility allows the user to make a zip file of the **RxLogger** folder in the device, which by default contains all the RxLogger logs stored in the device.

To save the backup data, touch  > **BackupNow**.

RxLogger Utility

RxLogger Utility is a data monitoring application for viewing logs in the device while RxLogger is running. Logs and RxLogger Utility features are accessed using Main Chat Head.

Initiating the Main Chat Head

To initiate the Main Chat Head:

1. Open **RxLogger**.
2. Touch  > **Toggle Chat Head**. The Main Chat Head icon appears on the screen.
3. Touch and drag the Main Chat head icon to move it around the screen.

Removing the Main Chat Head

To remove the Main Chat Head icon:

1. Touch and drag the icon. A circle with an X appears.
2. Move the icon over the circle and then release.

Viewing Logs

To view logs:

1. Touch the Main Chat Head icon. The RxLogger Utility screen appears.
2. Touch a log to open it. The user can open many logs with each displaying a new sub Chat Head.
3. If necessary, scroll left or right to view additional Sub Chat Head icons.
4. Touch a Sub Chat Head to display the log contents.

Removing a Sub Chat Head Icon

To remove a sub chat Head icon, press and hold the icon until it disappears.

Backing Up In Overlay View

RxLogger Utility allows the user to make a zip file of the **RxLogger** folder in the device, which by default contains all the RxLogger logs stored in the device.

The Backup icon is always available in Overlay View.

1. Touch . The Backup dialog box appears.
2. Touch **Yes** to create the back up.

VC Settings



NOTE: Ignition detect requires a CA1220 power extension cable.

Display

Enable/disable **Stay awake** to keep the device awake when the external power source is connected.

Peripheral Power

To provide power to an optional peripheral, turn on power to the appropriate port.

- **+12V output on USB Port 2** - Enable/disable additional power for the powered USB port.
- **+5V output on Serial Port 1** - Enable/disable power for serial port 1.
- **+5V output on Serial Port 2** - Enable/disable power for serial port 2.

Ignition Detection

Use Ignition Detection settings to control if the device turns on or off when the user turns on the ignition.



NOTE: Ignition detect requires a CA1220 power extension cable.

- **Ignition ON Turns on VC** - Enable/disable the device to turn on when the user turns the ignition on.
- **Ignition OFF shuts down VC** - Enable/disable the device to turn off when the user turns the ignition off.
- **Shut down VC after** - Select the number of minutes that the device turns off after the user turns off the ignition.

WIFI Antenna Switching

Use to select which Wi-Fi antenna to use.

- **Choose Antenna** - Select antenna. Options: **Internal Antenna** (default) or **External Antenna**.

Built-In Speaker

Enable/disable to keep the built-in speaker on when the optional M1000 Speaker/Microphone is connected.

Screen Blanking

The optional Screen Blanking setting turns the screen off when the vehicle is moving and back on when the vehicle stops.



NOTE: To use Screen Blanking, first connect one of the two DB9 serial ports on the device to a user-supplied switch or relay. See [Connecting Switch for Screen Blanking on page 31](#).

- **Screen Blanking** - Enable/disable screen blanking feature.
- **Input signal** - Select the port that the screen blank cable is connected to. Options: **Input 1** or **Input 2**.

- **Source polarity** - Select blank screen option. De-select to disconnect the blank screen option.
- **Blank screen delay** - Set the amount of time after the device receives the signal to blank the screen. Options 1 to 30 seconds (default - 1).

Velocity

Velocity transforms the traditional green screen telnet application into a modern smart device application. It accomplishes all of this without modifying the host application, offering workers a familiar experience optimized for today's touch screen mobile computers.

To open Velocity, swipe up from the Home screen and touch .

- Access the context menu for quick access to function or control keys.
- Access the Velocity menu for starting new sessions or switching between green and reformatted screens.

Refer to the Velocity user guide for more information. Goto <http://download.wavelink.com/Files/Velocity-qsg-28042016.pdf>

Data Capture

The VC8300 supports scanners that use the Human Interface Device (HID) and Simple Serial Interface (SSI) protocols. In HID mode, the scanner sends data to the VC8300 like entering characters on a keyboard. In SSI mode, the scanner sends data to the VC8300 in packets which can be ASCII data or as part of a larger message.

The VC8300 supports data capture using:

- Tethered scanner connected to COM1 or COM2 port:
 - DS3508-ER, HD, SR
 - DS3608-SR, ER, HP, HD
 - LI3608-SR
 - LS3408-ER, FZ
 - Other tethered serial scanners.
- Tethered scanner connected to a USB host port:
 - DS3508-ER, HD, SR (HID mode only)
 - DS3608-SR, ER, HP, HD (HID and SSI modes)
 - LI3608-SR (HID mode only)
 - LS3408-ER, FZ (HID mode only)
 - Other USB scanners (HID mode only).
- Wireless scanner connected via Bluetooth:
 - DS3678-SR, ER, HP, HD (HID and SSI modes)
 - LI3678-SR (HID mode only)
 - LS3578-ER, SR, HD, FZ (HID mode only)
 - DS3578-SR, ER, HD (HID mode only)
 - RS507/RS507x (HID and SSI modes)
 - RS5100 (HID and SSI modes)
 - RS6000 (HID and SSI modes)
 - Other Bluetooth scanners (HID mode only).

Imaging

The scanner with 2D imager has the following features:

- Omnidirectional reading of a variety of barcode symbologies, including the most popular linear, postal, PDF417, and 2D matrix code types.
- The ability to capture and download images to a host for a variety of imaging applications.
- Advanced intuitive laser aiming cross-hair and dot aiming for easy point-and-shoot operation.

The imager uses imaging technology to take a picture of a barcode, stores the resulting image in its memory, and executes state-of-the-art software decoding algorithms to extract the barcode data from the image.

Operational Modes

The imager supports two modes of operation, listed below. Activate each mode by pressing the Scan button.

- **Decode Mode:** In this mode, the scanner attempts to locate and decode enabled barcodes within its field of view. The imager remains in this mode as long as the user holds the scan button, or until it decodes a barcode.



NOTE: To enable Pick List Mode, configure in DataWedge or set in an application using a API command.

Picklist mode is dependent upon the scanner. Refer to the scanner user guide for more information.

- **Pick List Mode:** This mode allows the user to selectively decode a barcode when more than one barcode is in the scanner's field of view. To accomplish this, move the aiming crosshair or dot over the required barcode to decode only this barcode. This feature is ideal for pick lists containing multiple barcodes and manufacturing or transport labels containing more than one barcode type (either 1D or 2D).

Laser Scanning

Scanner with lasers has the following features:

- Reading of a variety of bar code symbologies, including the most popular linear, postal, and 1-D code types.
- Intuitive aiming for easy point-and-shoot operation.

Scanning Considerations

Typically, scanning is a simple matter of aim, scan, and decode and a few quick trial efforts master it. However, consider the following to optimize scanning performance:

- **Range:** Any scanning device decodes well over a particular working range — minimum and maximum distances from the barcode. This range varies according to barcode density and scanning device optics. Scanning within range brings quick and constant decodes; scanning too close or too far away prevents decodes. Move the scanner closer and further away to find the right working range for the barcodes being scanned.

- Angle: Scanning angle is important for promoting quick decodes. When laser beams reflect directly back into the scanner from the barcode, this specular reflection can “blind” the scanner. To avoid this, scan the barcode so that the beam does not bounce directly back. But don’t scan at too sharp an angle; the scanner needs to collect scattered reflections from the scan to make a successful decode. Practice quickly shows what tolerances to work within.
- Hold the scanner farther away for larger symbols
- Move the scanner closer for symbols with bars that are close together.



NOTE: Scanning procedures depend on the application and VC8300 configuration. An application may use different scanning procedures from the one listed above.

Barcode Capture with RS6000 Bluetooth Ring Scanner

To read a barcode, a scan-enabled application is required. The VC8300 contains the **DataWedge** application that allows the user to enable the scanner to decode barcode data and display the barcode content. See [DataWedge Demonstration on page 12](#) for more information on launching DataWedge.

Pair the RS6000 with the VC8300. See [Pairing the Ring Scanner on page 66](#) for more information.

1. Ensure that an application is open on the device and a text field is in focus (text cursor in text field).
2. Point the RS6000 at a barcode.

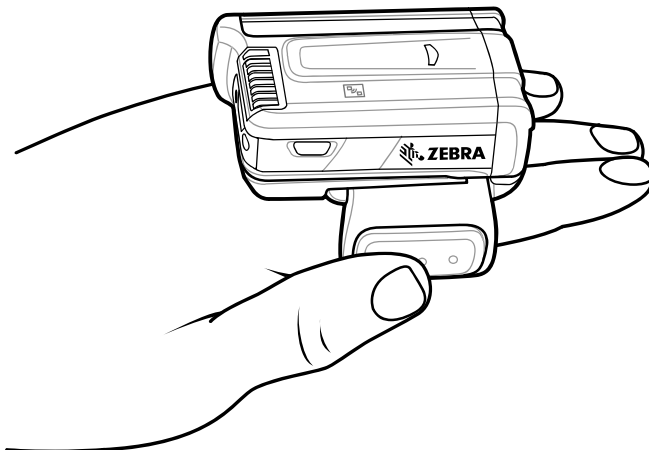

3. Press and hold the trigger.

The red laser aiming pattern turns on to assist in aiming. Ensure the barcode is within the area formed by the cross-hairs in the aiming pattern. The aiming dot is used for increased visibility in bright lighting conditions.

The RS6000 LEDs light green, a beep sounds to indicate the barcode was decoded successfully. Note that when the RS6000 is in Pick List Mode, the RS6000 does not decode the barcode until the center of the crosshair touches the barcode.

Figure 15 Aiming Pattern

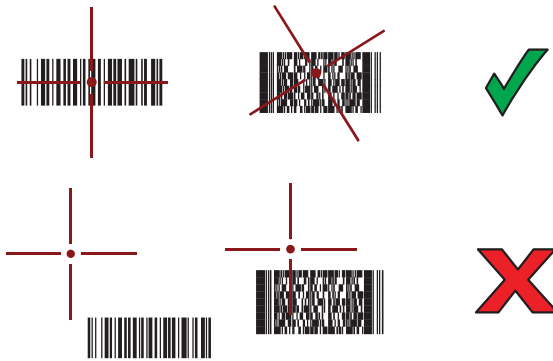

Figure 16 Pick List Mode with Multiple barcodes in Aiming Pattern



4. The captured data appears in the text field.

Barcode Capture with RS507/RS507x Hands-Free Imager

Pair the RS507/RS507x with the VC8300. See [Pairing the Ring Scanner on page 66](#) for more information. for more information.

1. Ensure that an application is open on the device and a text field is in focus (text cursor in text field).
2. Point the RS507/RS507x at a barcode.

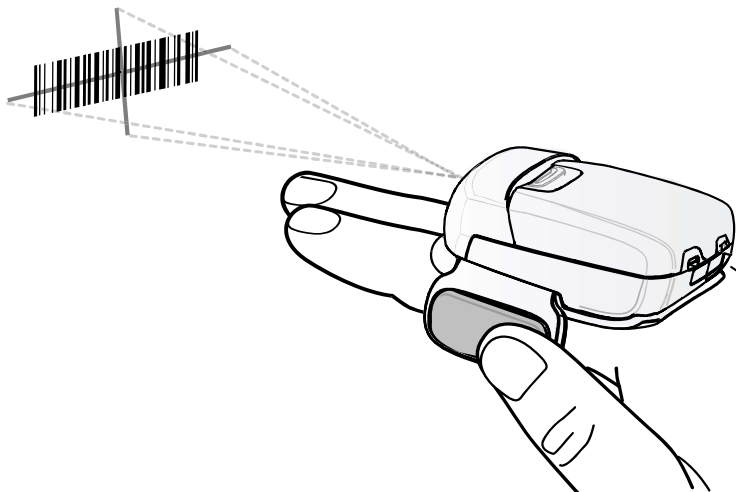

3. Press and hold the trigger.

The red laser aiming pattern turns on to assist in aiming. Ensure the barcode is within the area formed by the cross-hairs in the aiming pattern. The aiming dot is used for increased visibility in bright lighting conditions.

The RS507/RS507x LEDs light green, a beep sounds to indicate the barcode was decoded successfully. Note that when the RS507/RS507x is in Pick List Mode, the RS507/RS507x does not decode the barcode until the center of the crosshair touches the barcode.

Figure 17 Aiming Pattern

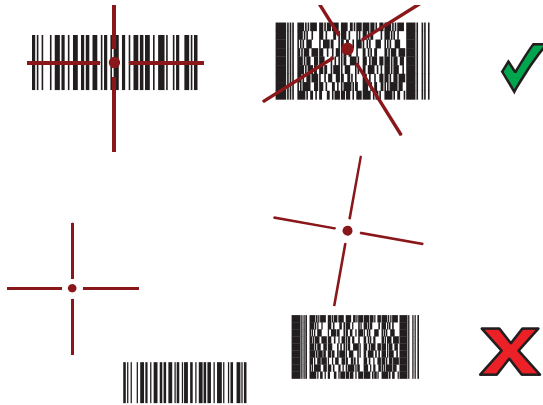

Figure 18 Pick List Mode with Multiple barcodes in Aiming Pattern



4. The captured data appears in the text field.

Bar Code Capture with RS5100

To read a barcode, a scan-enabled app is required. The device contains the DataWedge app that allows you to enable the scanner to decode barcode data and display the barcode content.

To scan with the RS5100:

1. Pair the RS5100 with the device. See [Pairing the Ring Scanner on page 66](#) for more information.
2. Ensure that an app is open on the device and a text field is in focus (text cursor in text field).

3. Point the RS5100 at a barcode.

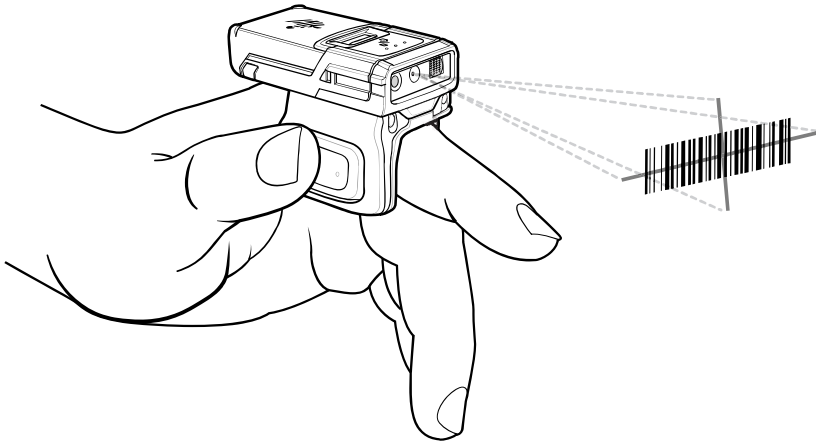

4. Press and hold the trigger.

The red laser aiming pattern turns on to assist in aiming. Ensure the barcode is within the area formed by the cross-hairs in the aiming pattern. The aiming dot increases visibility in bright lighting conditions.

The RS5100 LEDs light green and a beep sounds to indicate the barcode was decoded successfully. When the RS5100 is in Pick List mode, the RS5100 does not decode the barcode until the center of the crosshair touches the barcode.

Figure 19 RS5100 Aiming Pattern

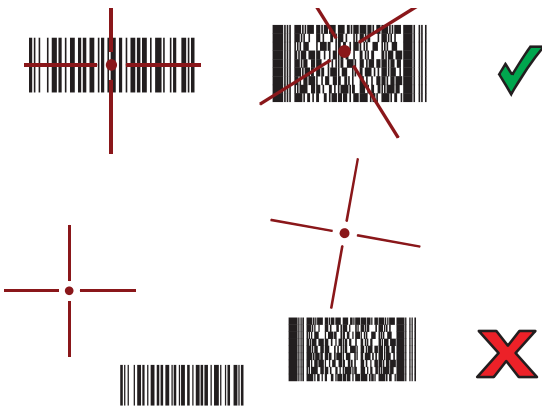

Figure 20 RS5100 Pick List Mode with Multiple Barcodes in Aiming Pattern



5. The captured data appears in the text field.

Bar Code Capture with Zebra Scanner

To capture barcodes data:

1. Ensure that an application is open on the device and a text field is in focus (text cursor in text field).
2. Point the scanner at a bar code.

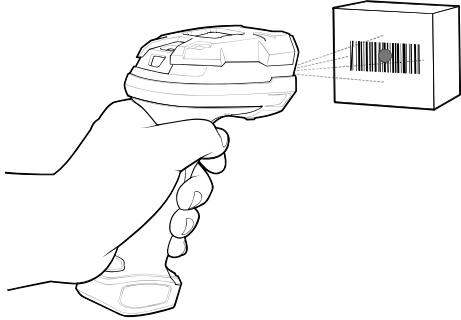

3. Press and hold the trigger.

Ensure the bar code is within the area formed by the aiming pattern. The aiming dot is used for increased visibility in bright lighting conditions. The aiming dot is used for increased visibility in bright lighting conditions.

Figure 21 DS3678-SR Aiming Pattern

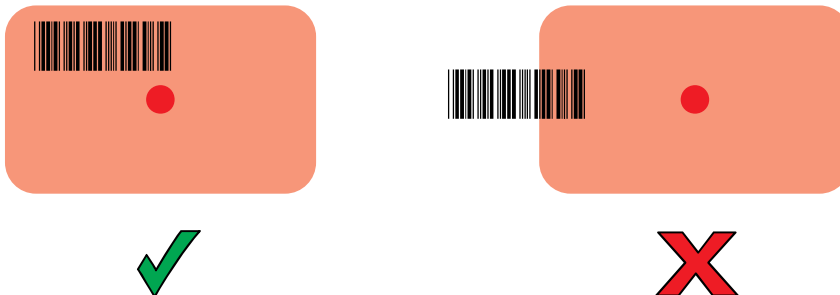
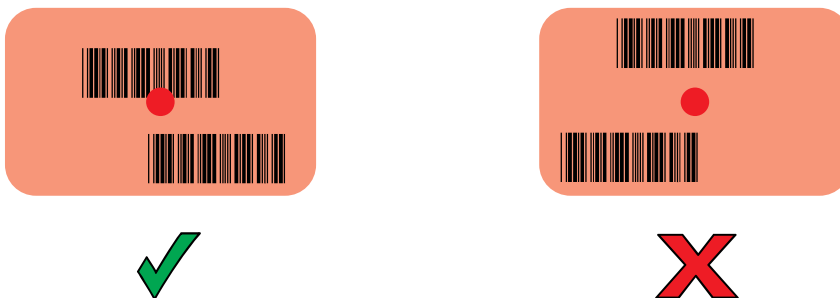

Figure 22 DS3678-SR Pick List Mode with Multiple Bar Codes in Aiming Pattern



4. The captured data appears in the text field.



Connecting an RS-232 Scanner

To connect an RS-232 scanner:

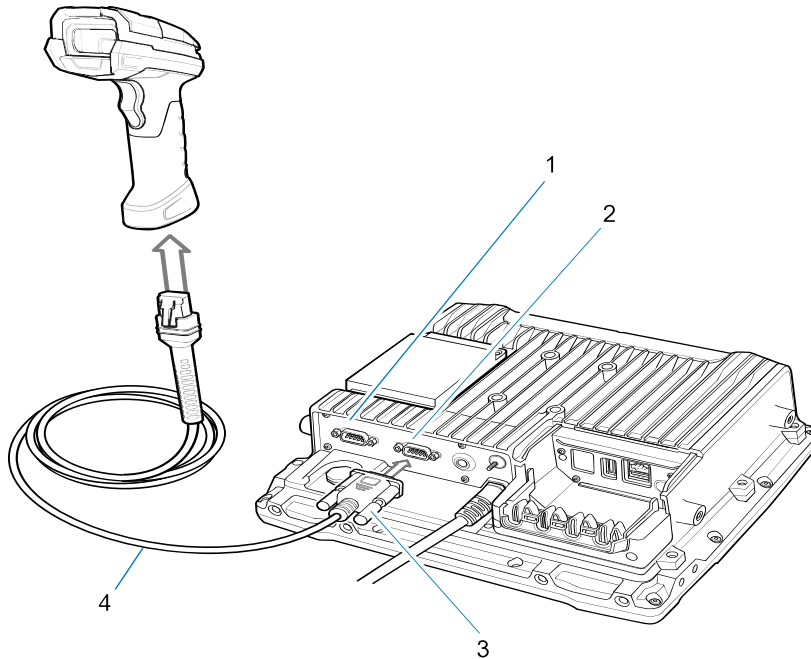
1. On the bottom of the VC8300, remove the connector cover from either the COM1 or COM2 port.
2. Connect the scanner cable RS-232 connector to either the COM1 or COM2 port and to the scanner.



1	COM 2 Port
2	COM 1 Port
3	Thumb screws
4	RS-232 Cable

3. Tighten the RS-232 connect thumb screws.
4. On the VC8300 home screen, swipe up from the bottom of the Home screen and touch .
5. Touch **+5V output on Serial Port 1** if the RS-232 scanner is connected to the COM1 port or **+5V output on Serial Port 2** if the scanner is connected to the COM 2 port. The scanner beeps.
6. Touch Home button.
7. Swipe up from the bottom of the Home screen and touch .
8. Select a profile.
9. Scroll down to **Serial port input from Serial port 1** or **Serial port input from Serial port 2**.
10. Touch **Enabled**. A check appears in the checkbox to the right.



CAUTION: By default, serial settings are set for all Zebra scanners. Other non-Zebra scanner may need configuration. Refer to the scanner user guide for more information.

11. Touch **Serial port configuration**.
12. Touch **Baud rate**.
13. Select one of the available baud rates.
14. Touch **Data bits**.
15. Select 7 or 8.
16. Touch **Parity**.

17. Select a parity value.
18. Touch **Stop bits**.
19. Select **1** or **2**.
20. Touch Back button.
21. Touch Home button.

Connecting a USB Scanner

To connect a USB scanner, use one of the following methods:

- Simple Serial Interface (SSI) mode
- Human Interface Device (HID) mode.

Connecting Using Simple Serial Interface



IMPORTANT: Make sure that DS3608 scanner has firmware version CAACJS00-004-R00D0.DAT or higher.

To connect a USB scanner using SSI mode:

1. On the back of the VC8300, remove the dust cover.
2. Connect the scanner cable USB connector to either USB port. The scanner beeps.

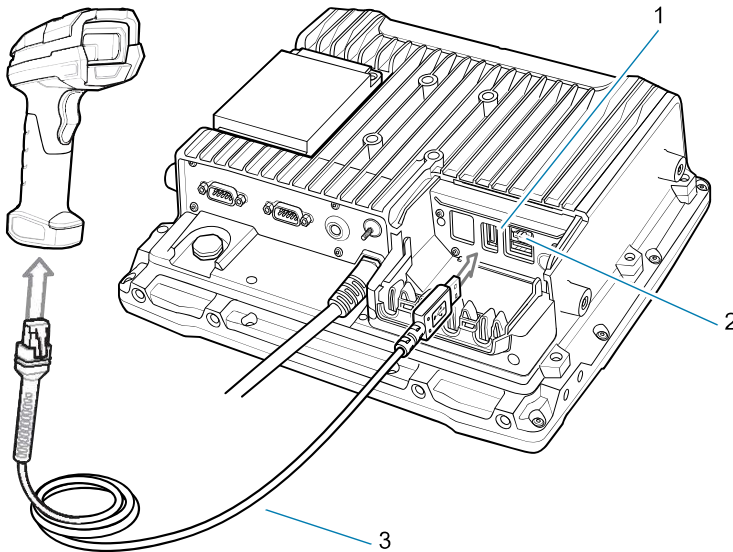

1	USB Port
2	USB Port
3	USB Cable

3. Place cable into strain relief.
4. Replace the dust cover.
5. Ensure that the scanner is in SSI mode. Refer to the scanner Product Reference Guide and scan the SSI Over USB CDC barcode.

6. On the VC8300 home screen, swipe up from the bottom of the Home screen and touch .
7. Select a profile.
8. Configure additional settings.

Connecting Using HID Mode

To connect a USB scanner using HID mode:

1. On the back of the VC8300, remove the dust cover.
2. Connect the scanner cable USB connector to either USB port. The scanner beeps.

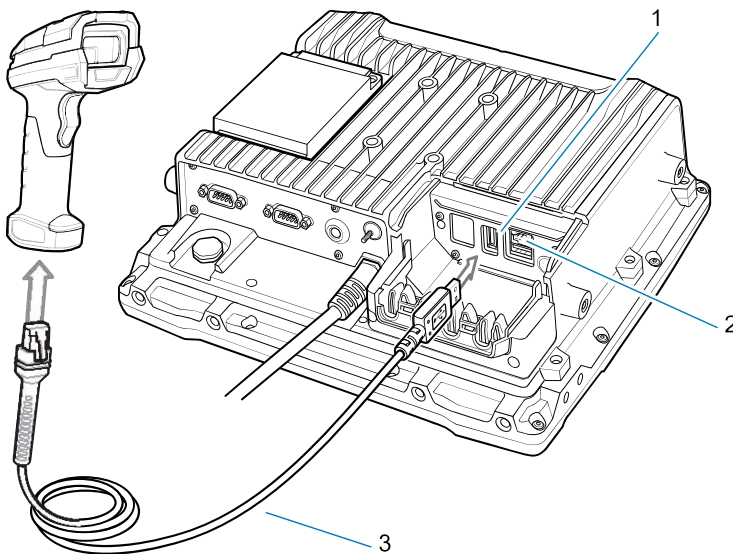

1	USB Port
2	USB Port
3	USB Cable

3. Place the cable into the strain relief.
4. Replace the dust cover.
5. Ensure that the scanner is in HID mode. Refer to the Product Reference Guide and scan the HID Keyboard barcode or perform a factory reset.

Pairing the Ring Scanner

To connect a ring scanner to the VC8300, use one of the following methods:

- Simple Serial Interface (SSI) mode
- Bluetooth Human Interface Device (HID) mode.

Pairing Using Simple Serial Interface

To pair the ring scanner with the VC8300 using SSI:

1. Ensure that the scanner is in SSI mode. If the ring scanner is already in SSI mode, skip to step 2.

- a. Remove the battery from the ring scanner.
 - b. Press and hold the Restore key.
 - c. Install the battery onto the ring scanner.
 - d. Keep holding the Restore key for about five seconds until a chirp is heard and the Scan LEDs flash green.
2. Ensure that the two devices are within 10 meters (32.8 feet) of one another.
 3. On the VC8300, swipe up from the bottom of the Home screen and touch .

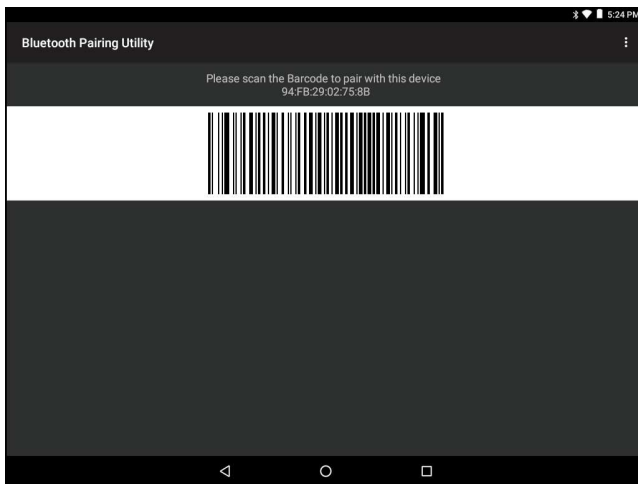

4. Using the ring scanner, scan the barcode on the screen or scan the barcode on the right side of the VC8300.

The ring scanner emits a high/low/high/low beeps. The Scan LED flashes green indicating that the scanner is attempting to establish connection with the VC8300. When connection is established, the Scan LED turns off and the scanner emits one string of low/high beeps.

5. On the VC8300, touch the Home button.

Pairing Using Human Interface Device

To pair the ring scanner with the VC8300 using HID:

1. Place the ring scanner in Human Interface Device (HID) mode. If the scanner is already in HID mode, skip to step 2.
 - a. Remove the battery from the ring scanner.
 - b. Press and hold the Restore key.
 - c. Install the battery onto the ring scanner.
 - d. Keep holding the Restore key for about five seconds until a chirp is heard and the Scan LEDs flash green.
 - e. Scan the barcode below to place the ring scanner in HID mode.

Figure 23 RS507/RS507x Bluetooth HID Barcode



Figure 24 RS5100/RS6000 Bluetooth HID Barcode



2. Remove the battery from the ring scanner.
3. Re-install the battery into the ring scanner.
4. Ensure that the two devices are within 10 meters (32.8 feet) of one another.
5. Swipe down from the status bar and then touch .
6. Touch **Bluetooth**.
7. The device begins searching for discoverable Bluetooth devices in the area and displays them under **AVAILABLE DEVICES**.
8. Scroll through the list and select the ring scanner.

The ring scanner connects to the scanner and **Connected** appears below the device name. The Bluetooth device is added to the **Paired devices** list and a trusted (“paired”) connection is established.

Pairing a DS3678 Scanner

To connect an DS3678 scanner to the VC8300, use one of the following methods:

- Simple Serial Interface (SSI) mode
- Bluetooth Human Interface Device (HID) mode.

Pairing Using Simple Serial Interface



CAUTION: Make sure that DS3678 scanner has firmware version CAACKS00-003-R00D0.DAT or higher.

To pair the DS3678 scanner with the VC8300 using SSI:

1. Ensure that the scanner is in SSI mode.
2. Ensure that the two devices are within 10 meters (32.8 feet) of one another.
3. On the VC8300, swipe up from the bottom of the Home screen and touch .

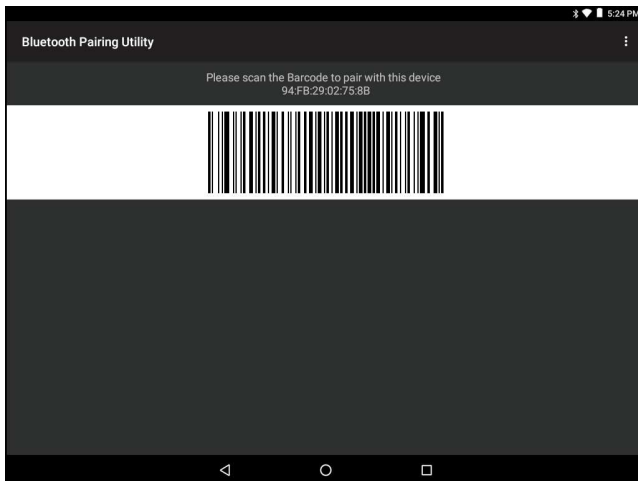

- Using the scanner, scan the barcode on the screen or scan the barcode on the right side of the VC8300.

The scanner emits a high/low/high/low beeps. The Scan LED flashes green indicating that the scanner is attempting to establish connection with the VC8300. When connection is established, the Scan LED turns off and the scanner emits one string of low/high beeps.

- On the VC8300, touch the Home button.

Pairing a DS3678 Scanner Using Human Interface Device



NOTE: The VC8300 supports Zebra DS3678, LI3678, LS3578, and DS3578 scanners in HID mode.

To pair the scanner with the VC8300 using HID:

- Ensure that the scanner is in HID mode. Refer to the DS36X8 Product Reference Guide and scan the HID Keyboard barcode.
- Ensure that the two devices are within 10 meters (32.8 feet) of one another.
- Swipe down from the status bar and then touch .
- Touch **Bluetooth**.
- The device begins searching for discoverable Bluetooth devices in the area and displays them under **AVAILABLE DEVICES**.
- Scroll through the list and select the scanner.

The device connects to the scanner and **Connected** appears below the device name. The Bluetooth device is added to the **Paired devices** list and a trusted (“paired”) connection is established.

DataWedge

DataWedge is a utility that adds advanced barcode scanning capability to any application without writing code. It runs in the background and handles the interface to built-in barcode scanners. The captured barcode data is converted to keystrokes and sent to the target application as if it was typed on the keypad.



DataWedge allows any app on the device to get data from input sources such as a barcode scanner, MSR, RFID, voice, or serial port and manipulate the data based on options or rules.

Configure DataWedge to:



- Provide data capture services from any app.
- Use a particular scanner, reader or other peripheral device.
- Properly format and transmit data to a specific app.

To configure DataWedge refer to techdocs.zebra.com/datawedge/.

Enabling DataWedge

- Swipe up from the bottom of the Home screen and touch .
- Touch  > **Settings**.
- Touch the **DataWedge enabled** checkbox. A blue checkmark appears in the checkbox indicating that DataWedge is enabled.
- Touch the Home button.

Disabling DataWedge



1. Swipe up from the bottom of the Home screen and touch .
2. Touch  > **Settings**.
3. Touch the **DataWedge enabled** checkbox. The blue checkmark disappears from the checkbox indicating that DataWedge is disabled.
4. Touch the Home button.

DataWedge

DataWedge is a utility that adds advanced barcode scanning capability to any application without writing code. It runs in the background and handles the interface to built-in barcode scanners. The captured barcode data is converted to keystrokes and sent to the target application as if it was typed on the keypad.

To configure DataWedge refer to techdocs.zebra.com/datawedge/.

Enabling DataWedge

1. Swipe up from the bottom of the Home screen and touch .
2. Touch  > **Settings**.
3. Touch the **DataWedge enabled** checkbox. A blue checkmark appears in the checkbox indicating that DataWedge is enabled.
4. Touch the Home button.

Disabling DataWedge

1. Touch .
2. Touch **Settings**.
3. Touch **DataWedge enabled**.

The blue check disappears from the checkbox indicating that DataWedge is disabled.

Supported Decoders



NOTE: DataWedge supports the decoders listed below but not all are validated on this device.

Table 10 Supported Decoders

Decoders	RS507/RS507X	RS5100	RS6000	DS2278	DS3578	DS3678	LI3678	DS8178
Australian Postal	O	O	O	O	O	O	--	O
Aztec	X	X	X	X	X	X	--	X
Canadian Postal	--	O	O	--	--	--	--	--
Chinese 2 of 5	O	O	O	O	O	O	O	O
Codabar	X	X	X	X	X	X	X	X
Code 11	O	O	O	O	O	O	O	O
Code 128	X	X	X	X	X	X	X	X
Code 39	X	X	X	X	X	X	X	X
Code 93	O	O	O	O	O	O	O	O
Composite AB	O	O	O	O	O	O	--	O
Composite C	O	O	O	O	O	O	--	O
Discrete 2 of 5	O	O	O	O	O	O	O	O
Datamatrix	X	X	X	X	X	X	--	X
Dutch Postal	O	O	O	O	O	O	--	O
DotCode	O	O	O	O	O	O	O	O
EAN13	X	X	X	X	X	X	X	X
EAN8	X	X	X	X	X	X	X	X
Grid Matrix	O	O	O	O	O	O	O	O
GS1 DataBar	X	X	X	X	X	X	X	X
GS1 DataBar Expanded	X	X	X	X	X	X	X	X
GS1 DataBar Limited	O	O	O	O	O	O	O	O
GS1 Datamatrix	--	O	O	O	O	O	--	O
GS1 QRCode	--	O	O	O	O	O	--	O
HAN XIN	--	O	O	--	--	O	O	--
Interleaved 2 of 5	O	O	O	O	O	O	O	O

Data Capture

Table 10 Supported Decoders (Continued)

Decoders	RS507/RS507X	RS5100	RS6000	DS2278	DS3578	DS3678	LI3678	DS8178
Japanese Postal	O	O	O	O	O	O	-	O
Korean 3 of 5	O	O	O	O	O	O	O	O
MAIL MARK	--	X	X	X	X	X	--	X
Matrix 2 of 5	O	O	O	O	O	O	O	O
Maxicode	X	X	X	X	X	X	--	X
MicroPDF	O	O	O	O	O	O	--	O
MicroQR	O	O	O	O	O	O	--	O
MSI	O	O	O	O	O	O	O	O
PDF417	X	X	X	X	X	X	--	X
QR Code	X	X	X	X	X	X	--	X
Decoder Signature	O	O	O	O	--	--	--	--
TLC 39	O	O	O	O	O	O	O	O
Trioptic 39	O	O	O	O	O	O	O	O
UK Postal	O	O	O	O	O	O	--	O
UPCA	X	X	X	X	X	X	X	X
UPCE0	X	X	X	X	X	X	X	X
UPCE1	O	O	O	O	O	O	O	O
US4state	O	O	O	O	O	O	--	O
US4state FICS	O	O	O	O	O	O	--	O
US Planet	O	O	O	O	O	O	--	O
US Postnet	O	O	O	O	O	O	--	O

Key

X = Enabled

O = Disabled

-- = Not Supported

Touch the Back button to return to the previous screen.

Wireless

This section provides information on the following wireless features:

- Wireless Local Area Network (WLAN)
- Bluetooth
- Near Field Communications (NFC)

Wireless Local Area Networks

Wireless local area networks (WLANs) allow the device to communicate wirelessly inside a building. Before using the device on a WLAN, the facility must be set up with the required hardware to run the WLAN (sometimes known as infrastructure). The infrastructure and the device must both be properly configured to enable this communication.

Refer to the documentation provided with the infrastructure (access points (APs), access ports, switches, Radius servers, etc.) for instructions on how to set up the infrastructure.

Once the infrastructure is set up to enforce the chosen WLAN security scheme, use the **Wireless & networks** settings configure the device to match the security scheme.

The device supports the following WLAN security options:

- None
- Enhanced Open
- Wireless Equivalent Privacy (WEP)
- Wi-Fi Protected Access (WPA)/WPA2 Personal (PSK)
- WPA3-Personal
- WPA/WPA2/WPA3 Enterprise (EAP)
 - Protected Extensible Authentication Protocol (PEAP) - with MSCHAPV2 and GTC authentication.
 - Transport Layer Security (TLS)
 - Tunneled Transport Layer Security (TTLS) - with Password Authentication Protocol (PAP), MSCHAP and MSCHAPv2 authentication
 - Password (PWD)
 - Lightweight Extensible Authentication Protocol (LEAP).
- WPA3-Enterprise 192-bit

The **Status** bar displays icons that indicate Wi-Fi network availability and Wi-Fi status.



NOTE: To extend the life of the battery, turn off Wi-Fi when not in use.

Connecting to a Wi-Fi Network

To connect to a Wi-Fi network:

1. Go to **Settings**.
2. Touch **Wi-Fi** to open the **Wi-Fi** screen. The device searches for WLANs in the area and lists them.
3. Scroll through the list and select the desired WLAN network.
4. For open networks, touch profile once or press and hold and then select **Connect** or for secure networks enter the required password or other credentials then touch **Connect**. See the system administrator for more information.

The device obtains a network address and other required information from the network using the dynamic host configuration protocol (DHCP) protocol. To configure the device with a fixed internet protocol (IP) address, see [Configuring the Device to Use a Static IP Address on page 77](#).

5. In the Wi-Fi setting field, **Connected** appears indicating that the device is connected to the WLAN.

Removing a Wi-Fi Network

To remove a remembered or connected network:

1. Go to **Settings**.
2. Touch **Network & Internet > W-Fi**.
3. Scroll down to the bottom of the list and touch **Saved networks**.
4. Touch the name of the network.
5. Touch **FORGET**.
6. Touch the Home button.

WLAN Configuration

This section provides information on configuring Wi-Fi settings.

Configuring a Secure Wi-Fi Network

1. Go to **Settings**.
2. Touch **Network & Internet > Wi-Fi**.
3. Slide the switch to the **ON** position.
4. The device searches for WLANs in the area and lists them on the screen.
5. Scroll through the list and select the desired WLAN network.
6. Touch the desired network. If the network security is **Open**, the device automatically connects to the network. For all other network security a dialog box appears.
7. If the network security is WPA/WPA2-Personal, WPA3-Personal, or WEP, enter the required password and then touch **Connect**.
8. If the network security is WPA/WPA2/WPA3 Enterprise:

- Touch the **EAP method** drop-down list and select one of the following:
 - **PEAP**
 - **TLS**
 - **TTLS**
 - **PWD**
 - **LEAP**.
 - Touch the **Phase 2 authentication** drop-down list and select an authentication method.
 - If required, touch **CA certificate** and select a Certification Authority (CA) certificate. Note: Certificates are installed using the **Security** settings.
 - If required, touch **User certificate** and select a user certificate. Note: User certificates are installed using the Security settings.
 - If required, in the **Identity** text box, enter the username credentials.
 - If desired, in the **Anonymous identity** text box, enter an anonymous identity username.
 - If required, in the **Password** text box, enter the password for then given identity.
9. If the network security is **WPA3-Enterprise 192-bit**:
- Touch **CA certificate** and select a Certification Authority (CA) certificate. Note: Certificates are installed using the **Security** settings.
 - Touch **User certificate** and select a user certificate. Note: User certificates are installed using the **Security** settings.
 - In the **Identity** text box, enter the username credentials.



NOTE: By default, the network Proxy is set to **None** and the IP settings is set to **DHCP**. See Configuring for a Proxy Server for setting connection to a proxy server and see Configuring the Device to Use a Static IP Address for setting the device to use a static IP address.

10. Touch **Connect**.
11. Touch the Home button.

Manually Adding a Wi-Fi Network

Manually add a Wi-Fi network if the network does not broadcast its name (SSID) or to add a Wi-Fi network when out of range.

1. Go to **Settings**.
2. Touch **Network & Internet > Wi-Fi**.
3. Slide the Wi-Fi switch to the **On** position.
4. Scroll to the bottom of the list and select **Add network**.
5. In the **Network name** text box, enter the name of the Wi-Fi network.
6. In the **Security** drop-down list, set the type of security to:
 - **None**
 - **WEP**
 - **WPA/WPA2-Personal**
 - **WPA3-Personal**

- **WPA/WPA2/WPA3-Enterprise**
 - **WPA3-Enterprise 192-bit**
7. If the network security is **None** , touch **Save**.
 8. If the network security is **WEP**, **WPA3-Personal**, or **WPA/WPA2-Personal**, enter the required password and then touch **Save**.
 9. If the network security is **WPA/WPA2/WPA3-Enterprise**:
 - Touch the **EAP method** drop-down list and select one of the following:
 - **PEAP**
 - **TLS**
 - **TTLS**
 - **PWD**
 - **LEAP**.
 - Touch the **Phase 2 authentication** drop-down list and select an authentication method.
 - If required, touch **CA certificate** and select a Certification Authority (CA) certificate. Note: Certificates are installed using the **Security** settings.
 - If required, touch **User certificate** and select a user certificate. Note: User certificates are installed using the **Security** settings.
 - If required, in the **Identity** text box, enter the username credentials.
 - If desired, in the **Anonymous identity** text box, enter an anonymous identity username.
 - If required, in the **Password** text box, enter the password for the given identity.
 10. If the network security is **WPA3-Enterprise 192-bit**:
 - Touch **CA certificate** and select a Certification Authority (CA) certificate. Note: Certificates are installed using the **Security** settings.
 - Touch **User certificate** and select a user certificate. Note: User certificates are installed using the **Security** settings.
 - In the **Identity** text box, enter the username credentials.
-  **NOTE:** By default, the network Proxy is set to **None** and the IP settings is set to **DHCP**. See [Configuring for a Proxy Server on page 76](#) for setting connection to a proxy server and see [Configuring the Device to Use a Static IP Address on page 77](#) for setting the device to use a static IP address.
11. Touch **Save**. To connect to the saved network, touch and hold on the saved network and select **Connect to network**.
 12. Touch the Home button.

Configuring for a Proxy Server

A proxy server is a server that acts as an intermediary for requests from clients seeking resources from other servers. A client connects to the proxy server and requests some service, such as a file, connection, web page, or other resource, available from a different server. The proxy server evaluates the request according to its filtering rules. For example, it may filter traffic by IP address or protocol. If the request is validated by the filter, the proxy provides the resource by connecting to the relevant server and requesting the service on behalf of the client.

It is important for enterprise customers to be able to set up secure computing environments within their companies, making proxy configuration essential. Proxy configuration acts as a security barrier ensuring that the proxy server monitors all traffic between the Internet and the intranet. This is normally an integral part of security enforcement in corporate firewalls within intranets.

1. Go to **Settings**.
2. Touch **Network & Internet > Wi-Fi**.
3. Slide the Wi-Fi switch to the **On** position.
4. In the network dialog box, select and touch a network.
5. Touch **Advanced options**.
6. Touch **Proxy** and select **Manual**.
7. In the **Proxy hostname** text box, enter the address of the proxy server.
8. In the **Proxy port** text box, enter the port number for the proxy server.
9. In the **Bypass proxy for** text box, enter addresses for web sites that are not required to go through the proxy server. Use a comma “,” between addresses. Do not use spaces or carriage returns between addresses.
10. Touch **Connect**.
11. Touch the Home button.

Configuring the Device to Use a Static IP Address

By default, the device is configured to use Dynamic Host Configuration Protocol (DHCP) to assign an Internet protocol (IP) address when connecting to a wireless network.

1. Go to **Settings**.
2. Touch **Network & Internet > Wi-Fi**.
3. Slide the Wi-Fi switch to the **On** position.
4. In the network dialog box, select and touch a network.
5. Touch **Advanced options**.
6. Touch **IP settings** and select **Static**.
7. In the **IP address** text box, enter an IP address for the device.
8. If required, in the **Gateway** text box, enter a gateway address for the device.
9. If required, in the **Network prefix length** text box, enter the prefix length.
10. If required, in the **DNS 1** text box, enter a Domain Name System (DNS) address.
11. If required, in the **DNS 2** text box, enter a DNS address.
12. Touch **Connect**.
13. Touch the Home button.

Wi-Fi Preferences

Use the **Wi-Fi preferences** to configure advanced Wi-Fi settings. From the Wi-Fi screen scroll down to the bottom of the screen and touch **Wi-Fi preferences**.

- **Turn on Wi-Fi automatically** - When enabled, Wi-Fi automatically turns back on when near high quality saved networks.

- **Open network notification** - When enabled, notifies the user when an open network is available.
- **Advanced** - Touch to expand options.
 - **Additional settings** - See Additional Settings.
 - **Install Certificates** – Touch to install certificates.
 - **Network rating provider** - Disabled (AOSP devices). To help determine what constitutes a good Wi-Fi network, Android supports external Network rating providers that provide information about the quality of open Wi-Fi networks. Select one of the providers listed or **None**. If none are available or selected, the Connect to open networks feature is disabled.
 - **Wi-Fi Direct** - Displays a list of devices available for a direct Wi-Fi connection.
 - **MAC address** - Displays the Media Access Control (MAC) address of the device when connecting to Wi-Fi networks.
 - **IP address** - Displays the IP address of the device when connecting to Wi-Fi networks.

Additional Wi-Fi Settings



NOTE: Additional Wi-Fi settings are for the device, not for a specific wireless network.

Use the **Additional Settings** to configure additional Wi-Fi settings. To view the additional Wi-Fi settings, scroll to the bottom of the **Wi-Fi** screen and touch **Wi-Fi Preferences > Advanced > Additional settings**.

- **Regulatory**
 - **Country Selection** - Displays the acquired country code if 802.11d is enabled, else it displays the currently selected country code.
 - **Region code** - Displays the current region code.
- **Band and Channel Selection**
 - **Wi-Fi frequency band** - Set the frequency band to: **Auto** (default), **5 GHz only** or **2.4 GHz only**.
 - **Available channels (2.4 GHz)** - Touch to display the **Available channels** menu. Select specific channels and touch **OK**.
 - **Available channels (5 GHz)** - Touch to display the **Available channels** menu. Select specific channels and touch **OK**.
- **Logging**
 - **Advanced Logging** – Touch to enable advanced logging or change the log directory.
 - **Wireless logs** - Use to capture Wi-Fi log files.
 - **Fusion Logger** - Touch to open the **Fusion Logger** application. This application maintains a history of high level WLAN events which helps to understand the status of connectivity.
 - **Fusion Status** - Touch to display live status of WLAN state. Also provides information about the device and connected profile.
- **About**
 - **Version** - Displays the current Fusion information.

Wi-Fi Direct

Wi-Fi Direct devices can connect to each other without having to go through an access point. Wi-Fi Direct devices establish their own ad-hoc network when required, letting you see which devices are available and choose which one you want to connect to.

1. Go to **Settings**.
2. Touch **Wi-Fi > Wi-Fi preferences > Advanced > Wi-Fi Direct**. The device begins searching for another Wi-Fi Direct device.
3. Under **Peer devices**, touch the other device name.
4. On the other device, select **Accept**.

Connected appears on the device. On both devices, in their respective Wi-Fi Direct screens, the other device name appears in the list.

Zebra Mobility Extensions

Zebra Mobility Extensions make use 802.11 specifications and Zebra proprietary extensions to achieve the highest level of performance, efficiency and reliability. The VC8300 adds support for the following Zebra Mobility Extensions.

- Coverage Hole Detection - The VC8300 includes enhancements to the IEEE 802.11k standard. These improvements will report gaps in signal coverage to the Zebra wireless LAN infrastructure. Network administrators can detect and mitigate coverage gaps present in the network for greater reliability. Default: enabled.
- Aggregated Fast Transition - Aggregated FT improves on IEEE 802.11r, Over-the-DS fast roaming. In conjunction with Zebra wireless LAN infrastructure, the VC8300 will achieve more reliable and consistent fast roaming. Default: enabled.
- Scan Assist - The VC8300 monitors neighbor access points and retrieves roaming related information from the Zebra wireless LAN infrastructure without doing scans. Using this Scan Assist feature, the VC8300 improves roaming. Default: enabled.

Bluetooth

Bluetooth devices can communicate without wires, using frequency-hopping spread spectrum (FHSS) radio frequency (RF) to transmit and receive data in the 2.4 GHz Industry Scientific and Medical (ISM) band (802.15.1). Bluetooth wireless technology is specifically designed for short-range (10 m (32.8 ft)) communication and low power consumption.

Devices with Bluetooth capabilities can exchange information (for example, files, appointments, and tasks) with other Bluetooth enabled devices such as printers, access points, and other mobile devices.

The device supports Bluetooth Low Energy. Bluetooth Low Energy is targeted at applications in the healthcare, fitness, security, and home entertainment industries. It provides reduced power consumption and cost while maintaining standard Bluetooth range.

Adaptive Frequency Hopping

Adaptive Frequency Hopping (AFH) is a method of avoiding fixed frequency interferers, and can be used with Bluetooth voice. All devices in the piconet (Bluetooth network) must be AFH-capable in order for AFH to work. There is no AFH when connecting and discovering devices. Avoid making Bluetooth connections and discoveries during critical 802.11b communications. AFH for Bluetooth consists of four main sections:

- Channel Classification - A method of detecting an interference on a channel-by-channel basis, or pre-defined channel mask.
- Link Management - Coordinates and distributes the AFH information to the rest of the Bluetooth network.
- Hop Sequence Modification - Avoids interference by selectively reducing the number of hopping channels.
- Channel Maintenance - A method for periodically re-evaluating the channels.

When AFH is enabled, the Bluetooth radio “hops around” (instead of through) the 802.11b high-rate channels. AFH coexistence allows enterprise devices to operate in any infrastructure.



NOTE: It is not recommended to perform Bluetooth wireless technology inquiry when high rate 802.11b operation is required.

Security

The current Bluetooth specification defines security at the link level. Application-level security is not specified. This allows application developers to define security mechanisms tailored to their specific need. Link-level security occurs between devices, not users, while application-level security can be implemented on a per-user basis. The Bluetooth specification defines security algorithms and procedures required to authenticate devices, and if needed, encrypt the data flowing on the link between the devices. Device authentication is a mandatory feature of Bluetooth while link encryption is optional.

Pairing of Bluetooth devices is accomplished by creating an initialization key used to authenticate the devices and create a link key for them. Entering a common personal identification number (PIN) in the devices being paired generates the initialization key. The PIN is never sent over the air. By default, the Bluetooth stack responds with no key when a key is requested (it is up to user to respond to the key request event). Authentication of Bluetooth devices is based-upon a challenge-response transaction. Bluetooth allows for a PIN or passkey used to create other 128-bit keys used for security and encryption. The encryption key is derived from the link key used to authenticate the pairing devices. Also worthy of note is the limited range and fast frequency hopping of the Bluetooth radios that makes long-distance eavesdropping difficult.

Recommendations are:

- Perform pairing in a secure environment
- Keep PIN codes private and do not store the PIN codes in the device
- Implement application-level security.

Bluetooth Profiles

The device supports the Bluetooth services listed.

Table 11 Bluetooth Profiles

Profile	Description
Service Discovery Protocol (SDP)	Handles the search for known and specific services as well as general services.
Serial Port Profile (SPP)	Allows use of RFCOMM protocol to emulate serial cable connection between two Bluetooth peer devices. For example, connecting the device to a printer.
Object Push Profile (OPP)	Allows the device to push and pull objects to and from a push server.
Advanced Audio Distribution Profile (A2DP)	Allows the device to stream stereo-quality audio to a wireless headset or wireless stereo speakers.
Audio/Video Remote Control Profile (AVRCP)	Allows the device to control A/V equipment to which a user has access. It may be used in concert with A2DP.
Personal Area Network (PAN)	Allows the use of Bluetooth Network Encapsulation Protocol to provide L3 networking capabilities over a Bluetooth link. Only PANU role is supported.
Human Interface Device Profile (HID)	Allows Bluetooth keyboards, pointing devices, gaming devices and remote monitoring devices to connect to the device.
Headset Profile (HSP)	Allows a hands-free device, such as a Bluetooth headset, to place and receive calls on the device.
Hands-Free Profile (HFP)	Allows car hands-free kits to communicate with the device in the car.
Phone Book Access Profile (PBAP)	Allows exchange of Phone Book Objects between a car kit and a mobile device to allow the car kit to display the name of the incoming caller; allow the car kit to download the phone book so you can initiate a call from the car display.
Out of Band (OOB)	Allows exchange of information used in the pairing process. Pairing is completed using the Bluetooth radio, but requires information from the OOB mechanism. Using OOB with NFC enables pairing when devices simply get close, rather than requiring a lengthy discovery process.
Symbol Serial Interface (SSI)	Allows for communication with Bluetooth Imager.
Generic Attribute Profile (GATT)	Provides profile discovery and description services for Bluetooth Low Energy protocol. It defines how attributes are grouped together into sets to form services.
Dial Up Networking (DUN)	Provides a standard to access the Internet and other dial-up services over Bluetooth.
Generic Access Profile (GAP)	Use for device discovery and authentication.
Object EXchange (OBEX)	Facilitates the exchange of binary objects between devices.

Bluetooth Power States

The Bluetooth radio is off by default.

- Suspend - When the device goes into suspend mode, the Bluetooth radio stays on.

- Airplane Mode - When the device is placed in Airplane Mode, the Bluetooth radio turns off. When Airplane mode is disabled, the Bluetooth radio returns to the prior state. When in Airplane Mode, the Bluetooth radio can be turned back on if desired.

Bluetooth Radio Power

Turn off the Bluetooth radio to save power or if entering an area with radio restrictions (for example, an airplane). When the radio is off, other Bluetooth devices cannot see or connect to the device. Turn on the Bluetooth radio to exchange information with other Bluetooth devices (within range). Communicate only with Bluetooth radios in close proximity.



NOTE: To achieve the best battery life, turn off radios when not in use.

Enabling Bluetooth

1. Swipe down from the Status bar to open the Notification panel.
2. Touch  to turn Bluetooth on.
3. Touch the Home button.

Disabling Bluetooth

1. Swipe down from the Status bar to open the Notification panel.
2. Touch  to turn Bluetooth off.
3. Touch the Home button.

Discovering Bluetooth Device(s)

The device can receive information from discovered devices without pairing. However, once paired, the device and a paired device exchange information automatically when the Bluetooth radio is on.

1. Ensure that Bluetooth is enabled on both devices.
2. Ensure that the Bluetooth device to discover is in discoverable mode.
3. Ensure that the two devices are within 10 meters (32.8 feet) of one another.
4. Swipe down from the Status bar to open the Quick Access panel.
5. Touch and hold **Bluetooth**.
6. Touch **Pair new device**. The device begins searching for discoverable Bluetooth devices in the area and displays them under **Available devices**.
7. Scroll through the list and select a device. The Bluetooth pairing request dialog box appears.
8. Touch **Pair** on both devices.
9. The Bluetooth device is added to the **Paired devices** list and a trusted (“paired”) connection is established.

Changing the Bluetooth Name

By default, the device has a generic Bluetooth name that is visible to other devices when connected.

1. Go to **Settings**.

2. Touch **Connected devices** > **Connection preferences** > **Bluetooth**.
3. If Bluetooth is not on, move the switch to turn Bluetooth on.
4. Touch **Device name**.
5. Enter a name and touch **RENAME**.
6. Touch the Home button.

Connecting to a Bluetooth Device

Once paired, connect to a Bluetooth device.

1. Go to **Settings**.
2. Touch **Connected devices** > **Connection preferences** > **Bluetooth**.
3. In the list, touch the unconnected Bluetooth device.

When connected, **Connected** appears below the device name.

Selecting Profiles on the Bluetooth Device

Some Bluetooth devices have multiple profiles.

1. Go to **Settings**.
2. Touch **Connected devices** > **Connection preferences** > **Bluetooth**.
3. In the **Paired Devices** list, touch  next to the device name.
4. Turn on or off a profile to allow the device to use that profile.
5. Touch the Home button.

Unpairing a Bluetooth Device

Unpairing a Bluetooth device erases all pairing information.

1. Go to **Settings**.
2. Touch **Connected devices** > **Connection preferences** > **Bluetooth**.
3. In the **Paired Devices** list, touch  next to the device name.
4. Touch **FORGET**.
5. Touch the Home button.

Cast

Use **Cast** to mirror the device screen on a Miracast enabled wireless display.

1. Go to **Settings**.
2. Touch **Connected devices** > **Connection preferences** > **Cast**.
3. Touch  > **Enable wireless display**.

The device searches for nearby Miracast devices and lists them.

4. Touch a device to begin casting.
5. Touch the Home button.

Accessories and Mounting

Introduction

This chapter provides accessory information, mounting options and instructions.

Accessories

Table 12 Accessories

Model Number	Description
Antennas	
AN2010	Antenna, dual band, 802.11 a/b/g/n/ac, 2 dBi, reverse polarity SMA connector, magnetic mount, 2.9 m (9.5 ft) cable.
AN2020	Antenna, 2.4 GHz, 802.11 b/g, 5 dBi, reverse polarity SMA connector, magnetic mount, 2.9 m (9.5 ft) cable.
AN2030	Whip antenna (stubby), dual band, 802.11 a/b/g/n/ac, 2.4 GHz 2 dBi, 5 GHz 3.7 dBi, reverse polarity SMA connector.
AR1000	Right Angle SMA reverse polarity plug-jack adapter.
Mounts	
MT4200	Quick release mount.
MT4205	Mounting plate for the MT4200 quick release mount.
MT4210	Adapter bracket kit for 82XX quick release mount.
MT4510	RAM rectangular base with 2.25" rubber ball.
MT4301	RAM mount, 4" arm.
MT4302	RAM mount, 12" arm.
MT3501	VESA base (for 4" or 12" RAM arm).
MT3502	Circular base (for 4" or 12" RAM arm).
MT3505	Clamp base (for 4" or 12" RAM arm), 2" max. width.
MT3507	Clamp base (for 4" or 12" RAM arm), 3" max. width.
MT3509	Rail base (for 4" or 12" RAM arm), 1-1/4" to 1-7/8".
MT3510	Rail base (for 4" or 12" RAM arm), 2" to 2-1/2"
KT-KYBDMNT-VC80-R	Function/Numeric keypad side mount bracket.

Accessories and Mounting

Table 12 Accessories (Continued)

Model Number	Description
MNT-VC80-ADPA1-1	Adapter for VC50 U-Mount.
MNT-VC80-ADPB1-1	Adapter for Honeywell U-Mount.
KT-U-MOUNT-VC80-R	U-Mount, with VC70 and 8585 / 8595 U-Mount hole pattern. Includes MNT-VC80-ADPA1-1 adapter.
Speaker/Mic	
M1000	Speaker/Mic with push-to-talk function.
Miscellaneous	
KT-VC80-BTRY1-01	Spare battery
WA4070	Ethernet to USB Dongle.
KT-AREFL-VC83-8-1	Anti Reflection Foil, pack of 3.
Power Supplies and Cables	
PS000145A01	100/240 VAC power supply, 24 VDC, 6.5 A, 150W (AC power cord sold separately)
PS1370	Pre-Regulator, 24 - 90 VDC in, 15 VDC out, 90 W
PS1450	100/240 VAC power supply, 12 VDC, 6 A. (AC power cord sold separately)
CB000417A01	DC power adapter to VC50 extension cable
CB000416A01	DC Power adapter to VC70 extension cable
CA1210	Power extension cable, DC, 6', waterproof
CA1230	Power extension cable for pre-regulator
CA1220	Power extension cable, DC, 180 cm, with ignition sense
CA1300	Screen blanking cable (DB9 to open wires)
A9169798	Adapter CPC to LXE/Honeywell VCX8, VX9, VM1, VM2 and VM3 DC Power Extension Cable.
A9169801	Adapter CPC and Serial to LXE VCX8 and VX9 DC Power Extension and Screen Blanking Cable.

VC8300 Antenna Options

Antenna hardware configurations are located in [Table 12 on page 84](#). To determine the best antenna option for your location, contact your Zebra representative.



CAUTION: If using a magnetic mount antenna, place it in a location that balances the need for the VC8300 to communicate with the access points and local Bluetooth peripherals.

Figure 25 VC8300 Antenna Options

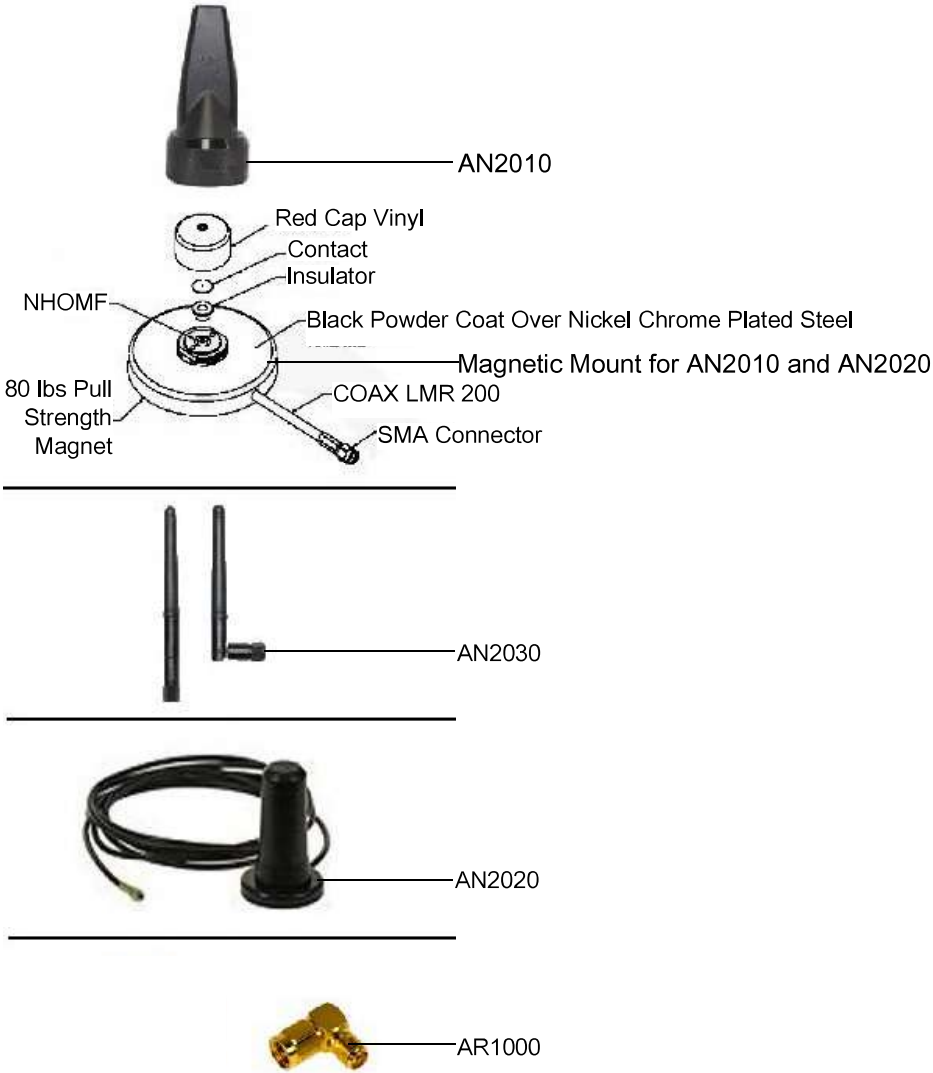

VC8300 Mounting Accessories



WARNING: Failure to install the mount correctly, or modifications to the mount, may result in serious injury or damage to property. Contact Zebra Technical Support or your Zebra representative if you have problems installing this mount. To ensure operator safety, you must use a calibrated torque wrench and the supplied mounting hardware when fastening the computer and mount. Use of this mount in vehicles driven on public roads or highways is prohibited. Contact Zebra for further details.

Before mounting a VC8300 in a vehicle, there are a number of operator safety issues that require careful attention. When mounting a VC8300 use only approved Zebra mounting hardware and mounting parts which are specific to the VC8300 model purchased. An improperly mounted VC8300 or use of non-approved parts may result in one or more of the following: operator injury, property damage, operator visibility obstruction, operator distraction, and/or poor ease of egress for the operator. Zebra strongly recommends that you seek professional mounting advice from the vehicle manufacturer.

If it is necessary to mount the VC8300 overhead, or in any position that could cause injury to the operator should the unit fall, it is critical that a secondary tether or other fail safe device be installed.

The following restrictions must be strictly enforced:

- Do not use the mount and/or the VC8300 as a hand-held. Using the mount in this manner may cause the person to fall or dislodge the mounting hardware and/or mounts.
- Do not add weight or attach any other items to the mount or VC8300. Additional elements may fall causing injury, or may increase the chance of failure and/or damage in mounting hardware and/or mounts.
- Mounts used in industrial or vibration generating environments may be subjected to fatigue, stress, and/or part wear. A periodic inspection of the mounting hardware and mounts should be performed to ensure parts are retightened to the correct torque, free of fractures, excessive wear, and/or other environmental damage. Any parts found to be unsafe should be removed and replaced immediately. After inspection or replacement of parts, readjust the mount as outlined in the pertinent sections below.
- Cable routing within a vehicle cab also requires careful consideration, especially for separately connected scanners and other devices with loose cables. If you are unable to obtain suitable advice, contact Zebra for assistance. For better protection, the equipment should be mounted inside the vehicle roll cage.
- When charging the vehicle battery, the VC8300 must be either disconnected from the battery or it must be determined that the maximum allowed input voltage of the VC8300 is not exceeded.

MT43XX RAM Mount



CAUTION: To avoid injury, this device must be properly secured when in a moving vehicle.

Keep this device away from magnetic fields.

Do not place the computer near a television or radio receiver.

Do not disassemble the VC8300 computer as there are no user-serviceable parts inside.



CAUTION: The operator can easily adjust the tilt and rotation of the VC8300. Use care to avoid operator injury or equipment damage if the computer slips due to a loosened hand screw.

The VC8300 may be installed using an articulating RAM Mount (Model MT43XX – 4 in. or 12 in. arm) secured to either a VESA or circular base.

The RAM articulating mount can be installed in a variety of orientations (see [Figure 30 on page 90](#)). Select the best orientation for the specific application. Preferred orientations maintain the center of mass of the computer assembly, directly over the center of the base.

For detailed mount installation information, refer to the instructions included with the mount kit.

Figure 26 Orientation of Vehicle-Mount Assembly

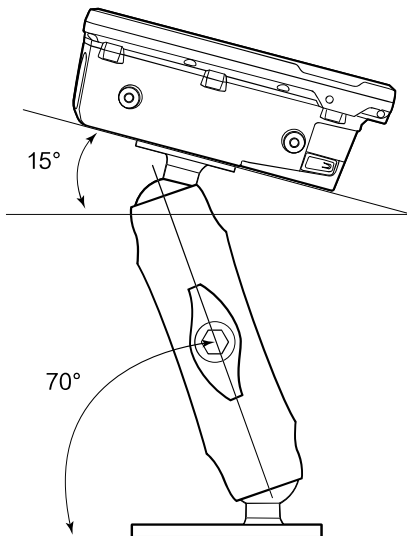

Optional Mounts

One of the following optional mounting kits shown below may be substituted for the Vesa base or the circular base when mounting to a post or forklift roll cage.

To assemble the optional mount kit:

1. Mount the clamp base and lower base around the shaft.
2. Place the screws through the clamp and the lower base, and affix with the nuts.
3. Torque to 26 in-lbs.
4. Secure the RAM standard arm by inserting the RAM balls into both ends of the arm sockets.

Figure 27 MT3505 Optional Mount Kits

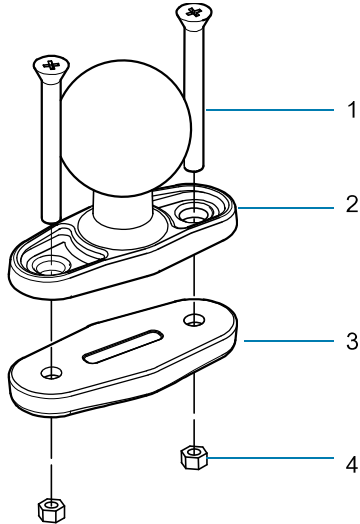

1	Screw
2	Clamp Base
3	Lower Base
4	Nut

Figure 28 MT3507 Optional Mount Kits

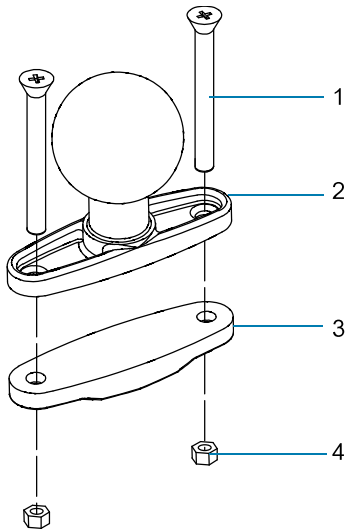

1	Screw
2	Clamp Base
3	Lower Base
4	Nut

Figure 29 MT3509 Optional Mount Kit

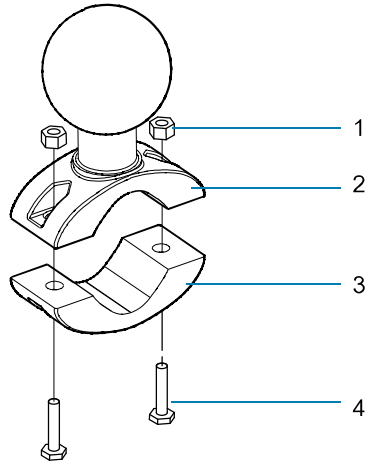

1	Nut
2	Clamp Base
3	Lower Base
4	Screw

Figure 30 MT3510 Optional Mount Kit

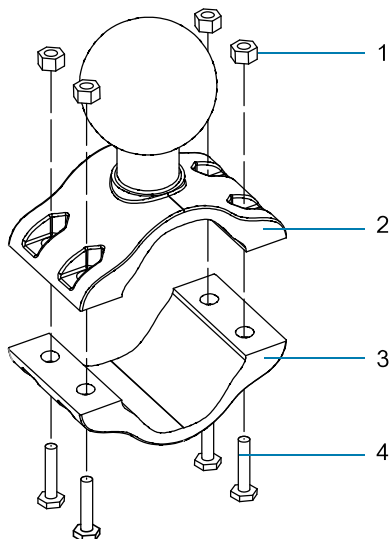

1	Nut
2	Clamp Base
3	Lower Base
4	Screw

Plate Bases for MT35XX Mounts

Plate bases are not recommended for forklift mounting solutions. If this requires a plate rather than a clamp base, you must penetrate into the structure of the vehicle. This requires additional hardware. The following plate bases are available:

- MT3501 - VESA Plate
- MT3502 - Circular Plate

MT4200 Quick Release Mount

The MT4200 Quick Release Mount allows for removal without the need for tools.

Assembling MT4200

To assemble the MT4200 Quick Release Mount:

1. Place the back mounting plate hooks into the base plate slots.
2. Snap spring clips into place.

Figure 31 MT4200 Quick Release Mount Assembly

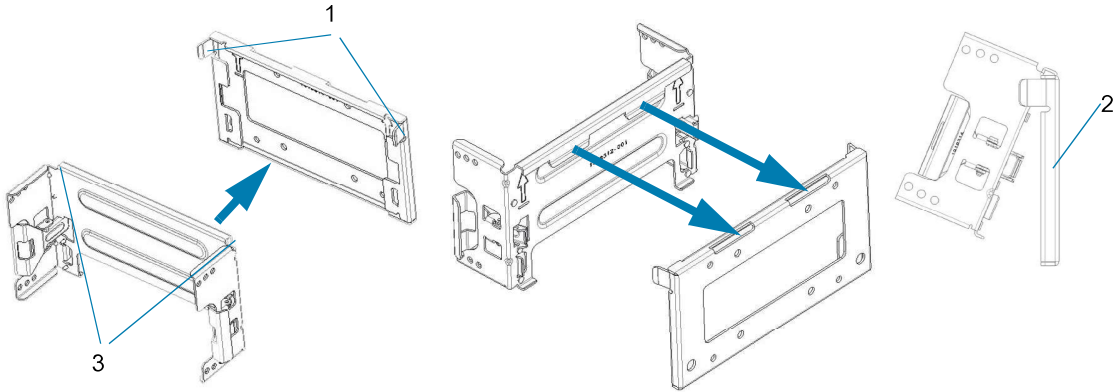

1	MT4200 Back Mounting Plate Hooks
2	Spring Clip
3	MT4205 Base Plate Slots

Attaching MT4200 to VC8300

To attach the MT4200 Quick Release Mount to the VC8300:

- 1. Line up the MT4200 mounting bracket holes with the holes on the sides of the VC8300 (two on each side).
- 2. Place the spring lock washer onto the hex head screw.
- 3. Place the flat washer onto the hex head screw (on top of the washer spring lock).
- 4. Screw the bracket onto the VC8300 (total of four). Torque to 34.7 in-lbs.

Figure 32 VC8300 and MT4200 Assembly

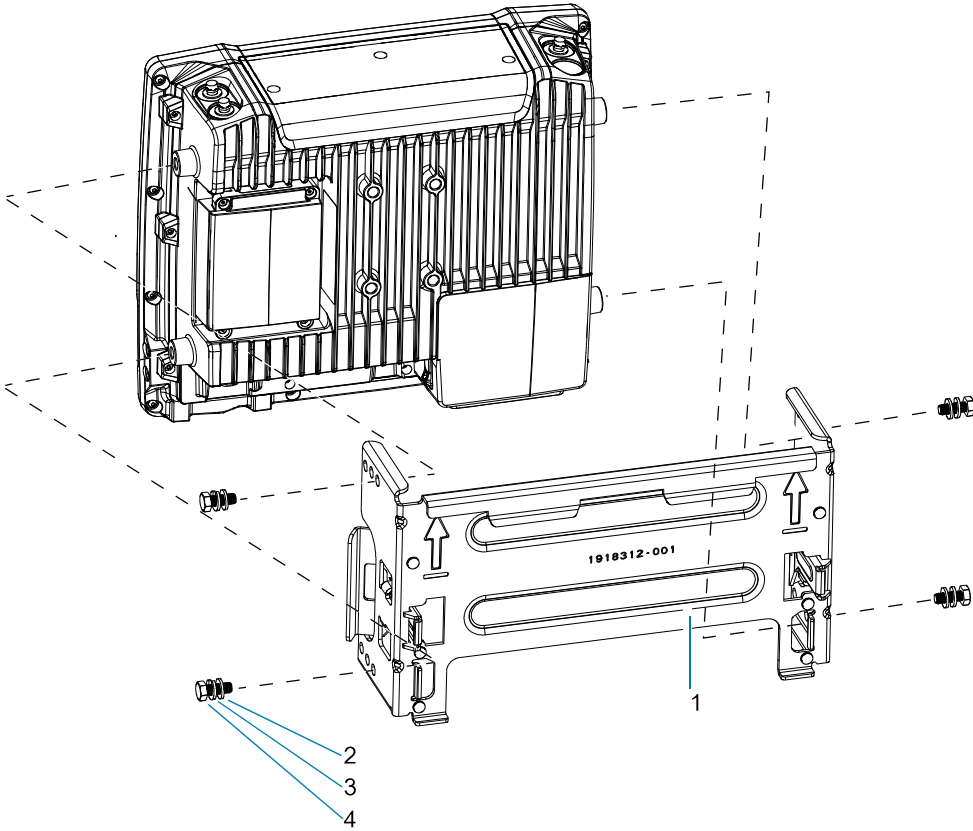

1	MT4200 Mounting Bracket (Back View)
2	Washer Flat
3	Washer Spring Lock
4	Hex Head Screw M6X12

MT4210 Adapter Bracket

The MT4210 Adapter Bracket is for use with older mounts, such as the 82XX Quick Release Mount.

To assemble the MT4210 Adapter Bracket:

- 1. Line up the MT4210 mounting bracket holes with the holes on the sides of the VC8300 (two on each side).
- 2. Place the spring lock washer onto the hex head screw.
- 3. Place the flat washer onto the hex head screw (on top of the washer spring lock).
- 4. Screw the metal adapter bracket onto the VC8300 (total of four). Torque to 34.7 in-lbs.

Figure 33 MT4210 Adapter Bracket Assembly

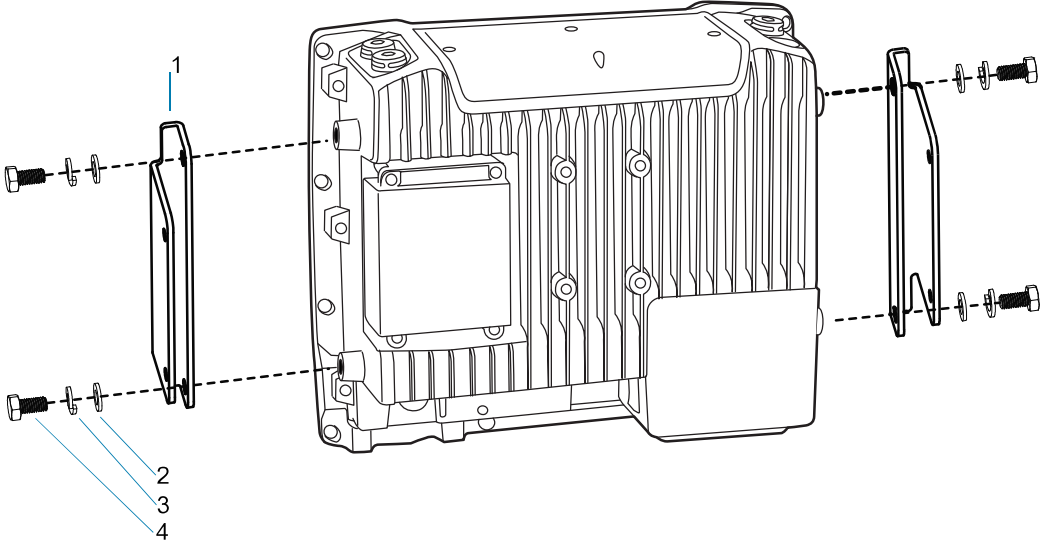



1	Metal Adapter Bracket
2	Washer Flat
3	Washer Spring Lock
4	Hex Head Screw M6X12

Settings

Accessing Settings

There are multiple ways to access settings on a device.

- Swipe down with two fingers from the top of the Home screen to open the Quick Access panel and touch .
- Double-swipe down from the top of the Home screen to open the Quick Access panel and touch .
- Swipe up from the bottom of the Home screen to open APPS and touch  **Settings**.

Display Settings

Use Display settings to change the screen brightness, enable night light, change the background image, enable screen rotation, set sleep time, and change font size.

Setting the Screen Brightness Manually

Manually set the screen brightness using the touchscreen.

1. Swipe down with two fingers from the Status bar to open the Quick Access panel.
2. Slide the icon to adjust the screen brightness level.

Setting Night Light

The Night Light setting tints the screen amber, making the screen easier to look at in low light.

1. Go to **Settings**.
2. Touch **Display**.
3. Touch **Night Light**.
4. Touch **Schedule**.
5. Select one of the schedule values:
 - None (default)
 - Turns on at custom time
 - Turns on from sunset to sunrise.
6. By default, **Night Light** is disabled. Touch **TURN ON NOW** to enable.
7. Adjust the tint using the **Intensity** slider.

8. Touch the Home button.

Setting Screen Rotation

By default, screen rotation is enabled.

1. Go to **Settings**.
2. Touch **Display > Advanced**.
3. Touch **Auto-rotate screen**.



NOTE: To change the Home screen rotation, see [Setting Home Screen Rotation on page 34](#).

4. Touch the Home button.

Setting Screen Timeout

Set the screen sleep time.

1. Go to **Settings**.
2. Touch **Display > Advanced > Screen timeout**.
3. Select one of the sleep values.
 - **15 seconds**
 - **30 seconds**
 - **1 minute** (default)
 - **2 minutes**
 - **5 minutes**
 - **10 minutes**
 - **30 minutes**
4. Touch the Home button.

Lock Screen Display

The lock screen display setting wakes the screen when notifications are received.

1. Go to **Settings**.
2. Touch **Display > Advanced**.
3. Touch **Lock screen display**.
4. In the **When to show** section, enable or disable an option using the switch.
5. Touch the Home button.

Setting Font Size

Set the size of the font in system apps.

1. Go to **Settings**.
2. Touch **Display > Advanced**.

3. Touch **Font size**.
4. Select one of the font size values.
 - Small
 - Default
 - Large
 - Largest.
5. Touch the Home button.

Touch Panel Mode

The device display is able to detect touches using a finger, a conductive-tip stylus, or gloved finger.



NOTE: A glove can be made of medical latex, leather, cotton, or wool. For optimal performance use a Zebra certified stylus.

1. Go to **Settings**.
2. Touch **Display > Advanced**.
3. Touch **Touch panel mode**.
4. Select:
 - **Glove and Finger (Screen Protector off)** to use a finger or a gloved finger on the screen without a screen protector.
 - **Finger Only** to use a finger on the screen.
 - **Glove and Finger (Screen Protector on)** to use a finger or a gloved finger on the screen with a screen protector.
 - **Finger and Stylus** to use a finger or a stylus on the screen.
 - **Finger and Glove** to use a finger or a gloved finger on the screen.
5. Touch the Home button.

Setting the Date and Time

You are only required to set the time zone or set the date and time if the wireless LAN does not support Network Time Protocol (NTP).

1. Go to **Settings**.
2. Touch **System > Date & time**.
3. Touch **Use network-provided time** to disable automatic date and time synchronization.
4. Touch **Date**.
5. In the calendar, set today's date.
6. Touch **OK**.
7. Touch **Time**.
8. Touch the green circle, drag to the current hour and then release.
9. Touch the green circle, drag to the current minute and then release.
10. Touch **AM** or **PM**.

11. Touch **OK**.
12. Select the current time zone from the list.
13. Touch **Use 24-hour format**.
14. Touch the Home button.

Keyboard Backlight

The intensity of the keyboard backlight and the conditions under which this backlight is activated can be configured by opening the Keyboard Light settings.

1. Swipe down select settings.
2. Touch **Display > Advanced > Keyboard backlight**.
3. Touch **Keyboard light level**. A slider appears.
4. Adjust the light level by sliding the icon. Change level by 10% increments.
5. Touch **Keyboard light timeout**. The Keyboard light timeout dialog appears.
6. Select the amount of time that the backlight stays on before turning off.
 - 6 seconds (default)
 - 10 seconds
 - 15 seconds
 - 30 seconds
 - 1 minute
 - 2 minute
 - 5 minute
 - Always on.
7. Touch Home button.



General Sound Setting

Use the **Sound** settings to configure media and alarm volumes.

1. Go to **Settings**.
2. Touch **Sound**.
3. Touch an option to set sounds.

Sound Options

- **Zebra volume controls**
 - **Ring volume** - Controls the ringtone volume.
 - **Media volume** - Controls the music, games, and media volume.
 - **Alarm volume** - Controls the alarm clock volume.
 - **Notifications volume** - Controls the notification volume.
 - **Scanner volume** - Controls the scanner volume.

- **Volume presets**
 -  - Mutes the ring, notifications, and scanner so that the device does not make sounds or vibrate.
 -  - Enables all sounds at the user defined levels.
- **Do Not Disturb** - Mutes some or all sounds and vibrations.
- **Shortcut to prevent ringing** - Select how the shortcut method prevents ringing.
- **Default notification sound** - Select a sound to play for all system notifications.
- **Default alarm sound** - Select a sound to play for alarms.
- **Other sounds and vibrations**
 - **Screen locking sounds** - Play a sound when locking and unlocking the screen (default – enabled).
 - **Charging sounds and vibration** - Plays a sound and vibrates when power is applied to the device (default - enabled).
 - **Touch sounds** - Play a sound when making screen selections (default – enabled).
- **Wireless Emergency alerts** - Touch to configure emergency broadcast settings and notifications.

Remapping a Button

Buttons on the device can be programmed to perform different functions or as shortcuts to installed apps. For a list of key names and descriptions, refer to: techdocs.zebra.com.

1. Go to **Settings**.
2. Touch **Key Programmer**. A list of programmable buttons displays.
3. Select the button to remap.
4. Touch the **BUTTON REMAPPING** tab or the **SHORTCUT** tab that lists the available functions and applications.
5. Touch a function or application shortcut to map to the button.



NOTE: If you select an application shortcut, the application icon appears next to the button on the Key Programmer screen.

6. Touch the Home button.

Keyboards

The device provides multiple keyboard options.

- Enterprise Keyboard



NOTE: By default the Enterprise and Virtual Keyboards are disabled.

Keyboard Configuration



Enabling Keyboards

1. Go to **Settings**.
2. Touch **System > Languages & input > Virtual keyboard > Manage keyboards**.

3. Touch a keyboard to enable.

To enable a virtual keyboard like Gboard or Enterprise keyboard:

Switching Between Keyboards

- To switch between keyboards, touch in a text box to display the current keyboard.
 - On the Gboard keyboard, touch and hold  (GMS devices only).
 - On the Android keyboard, touch and hold  (AOSP devices only).
 - On the Enterprise keyboard, touch . Only available with Mobility DNA Enterprise License. Not pre-installed on the device. Contact Zebra Support for more information.

Using the Android and Gboard Keyboards

Use the Android or Gboard keyboards to enter text in a text field.

To configure the keyboard settings, touch and hold , (comma) and then select **Android keyboard settings**.

Edit Text

Edit entered text and use menu commands to cut, copy, and paste text within or across apps. Some apps do not support editing some or all of the text they display; others may offer their own way to select text.

Entering Numbers, Symbols, and Special Characters

1. Enter numbers and symbols.
 - Touch and hold one of the top-row keys until a menu appears then select a number or special character.
 - Touch the Shift key once for a single capital letter. Touch the Shift key twice to lock in uppercase. Touch the Shift key a third time to unlock Capslock.
 - Touch **?123** to switch to the numbers and symbols keyboard.
 - Touch the **=\<** key on the numbers and symbols keyboard to view additional symbols.
2. Enter special characters.
 - Touch and hold a number or symbol key to open a menu of additional symbols. A larger version of the key displays briefly over the keyboard.

Using the Enterprise Keyboard

The Enterprise Keyboard contains multiple keyboard types.

- Numeric
- Alpha
- Special characters
- Data capture.

Numeric Tab

The numeric keyboard is labeled **123**. The keys displayed vary on the app being used. For example, an arrow displays in **Contacts**, however **Done** displays in **Email** account setup.

Alpha Tab

The alpha keyboard is labeled using the language code. For English, the alpha keyboard is labeled **EN**.

Additional Character Tab

The additional characters keyboard is labeled **#*/**.

Touch  to enter emoji icons in a text message.

Touch **ABC** to return to the Symbols keyboard.

Scan Tab

The Scan tab provides an easy data capture feature for scanning barcodes.

Integrated Keyboard

The device is available with an integrated keyboard in either QWERTY or AZERTY alphanumeric keyboard layout. It features 54 keys, 12 direct function keys, and a power button.

Most of the keys on the keyboard operate much like a desktop computer. Where a key or key function is not consistent with the keyboard, those differences are described in the following sections.

There are a number of modifier keys that provide access to additional keys and system functions.

See [Keyboard Backlight on page 98](#) for information on adjusting the keyboard backlight.

Figure 34 Integrated Keyboard



Table 13 Key Descriptions

Key	Function
Regular Keys	
The Arrow Keys	The arrow keys are located near the bottom of the keyboard, and are represented on the keyboard as triangles pointing in different directions. The keys move the cursor around the screen in the direction of the arrow: up, down, left, and right. The left arrow key should not be confused with the backspace DEL key which is depicted as a left arrow. The cursor is the flashing box or underline character that indicates where the next character you type will appear.
The DEL Key	The DEL key (represented on the keyboard as an arrow pointing left) is the backspace key that moves the cursor one character to the left, erasing the previous key stroke. The [Blue] + DEL keys erase the character at the current cursor position.
The SHIFT Key	The SHIFT key is used to display uppercase alpha characters. ↑ appears in the status bar. Pressing the SHIFT key a second time locks the keys that all alpha characters are uppercase. ↓ appears in the status bar. Press the SHIFT key again to return to the default keypad functions.

Table 13 Key Descriptions (Continued)

Key	Function
The CTRL and ALT Keys	The CTRL and ALT keys modify the function of the next key pressed and are application dependent. C or A appears in the status bar. Pressing the CTRL or ALT key a second time locks the keys. ⌘ or ⌘ appears in the status bar. Press the key again to return to the default keypad functions.
The TAB Key	Typically, the TAB key moves the cursor to the next field to the right or downward.
The ESC Key	Generally, this key is used as a keyboard shortcut to close the current menu, dialog box, or activity.
The SPACE Key	Pressing this key inserts a blank space between characters. In a dialog box, pressing the SPACE key enables or disables a check box.
The INS Key	The INS key inserts a character at the cursor position.
Function Keys	
F1 - F12	Function keys perform special, custom-defined functions within an application. These keys are accessed by pressing one of the dedicated function keys on the keyboard, or through the appropriate [Blue] key sequence. To access the blue function keys, first press the [Blue] key followed by the appropriate function key. Function keys can be used with the operating system or another application.
Programmable Keys	
P1 - P5	The device keyboard is equipped with a series of programmable keys that can be programmed to replace frequently used keystrokes, along with the function of executable keys like the ENTER key, the [BACKSPACE] key, any function key, arrow key, etc.
Special Keys	
Diamond Key	The Diamond key provides access to commonly used symbolic characters. Pressing the key brings up the soft input panel (SIP) on-screen keyboard, with symbols mapped to each key.
Blue Key	The [Blue] key provides access to additional keys. These functions are color coded in blue print on the key caps.

Soft Input Panel

The SIP provides additional commonly used symbolic characters that do not appear on the integrated keyboard. Press the Diamond key to show the SIP. Press the Diamond key a second time to lock the SIP in place. Press the Diamond key a third time to hide the SIP. Press and hold up arrow/down arrow key and slide up and down to re-position the SIP on the screen.

Figure 35 Soft Input Panel

=	+	-	×	÷	()	\	/	~	&	£
[]		{	}	€	?	;	:	#	`	'
↑↓	<	>	_	"	*	^	%	\$	#	!	↑↓

Language Usage

Use the **Language & input** settings to change the device's language, including words added to the dictionary.

Changing the Language Setting

1. Go to **Settings**.
2. Touch **System > Languages & input**.
3. Touch **Languages**. A list of available languages displays.
4. If the desired language is not listed, touch **Add a language** and select a language from the list.
5. Touch and hold  to the right of the desired language, then drag it to the top of the list.
6. The operating system text changes to the selected language.

Adding Words to the Dictionary

1. Go to **Settings**.
2. Touch **System > Languages & input > Advanced > Personal dictionary**.
3. If prompted, select the language where this word or phrase is stored.
4. Touch **+** to add a new word or phrase to the dictionary.
5. Enter the word or phrase.
6. In the **Shortcut** text box, enter a shortcut for the word or phrase.
7. Touch the Home button.

Notifications

Setting App Notifications

To set notification settings for a specific app:

1. Go to **Settings**.
2. Touch **Apps & notifications > SEE ALL XX APPS**. The **App info** screen displays.
3. Select an app.
4. Touch **Notifications**.

Options vary depending on the app selected.

5. Select an available option:

Show notifications - Select to turn all notifications from this app on (default) or off.

Touch a notification category to display additional options.

- **Alerting** - Allow notifications from this app to make sound or vibrate the device.
 - **Pop on screen** - Allow notifications from this app to pop notifications on the screen.
 - **Silent** - Do not allow notifications from this app to make sound or vibrate.
 - **Minimize** - In the Notification panel, collapse notifications to one line.
 - **Advanced** - Touch for additional options.

- **Sound** - Select a sound to play for notifications from this app.
- **Vibrate** - Allow notifications from this app to vibrate the device.
- **Blink light** - Allow notifications from this app the light the Notification LED blue.
- **Show notification dot** - Allow notifications from this app to add a notification dot to the app icon.
- **Override Do Not Disturb** - Allow these notifications to interrupt when Do Not Disturb is enabled.

Advanced

- **Allow notification dot** - Do not allow this app to add a notification dot to the app icon.
- **Additional settings in the app** - Open the app settings.

Viewing Notification Settings for All Apps

To view the notification settings for all apps:

1. Go to **Settings**.
2. Touch **Apps & Notifications**.
3. Scroll down to **Notifications** to view how many apps have notifications turned off.
4. To set or view notifications settings for a specific app, see Setting App Notifications.

Controlling Lock Screen Notifications

To control whether notifications can be seen when the device is locked:

1. Go to **Settings**.
2. Touch **Apps & notifications > Notifications**.
3. Touch **Notifications on lockscreen** and select one of the following:
 - **Show alerting and silent notifications** (default)
 - **Show alerting notifications only**
 - **Don't show notifications**.

Blink Light

The Notification LED lights blue when an app, such as email and VoIP, generates a programmable notification or to indicate when the device is connected to a Bluetooth device. By default, LED notifications are enabled.

To change the notification setting:

1. Go to **Settings**.
2. Touch **Apps & notifications > Notifications > Advanced**.
3. Touch **Blink light** to toggle the notification on or off.

Application Deployment

Security

The device implements a set of security policies that determine whether an application is allowed to run and, if allowed, with what level of trust. To develop an application, you must know the security configuration of the device, and how to sign an application with the appropriate certificate to allow the application to run (and to run with the needed level of trust).



NOTE: Ensure the date is set correctly before installing certificates or when accessing secure web sites.

Secure Certificates

If the VPN or Wi-Fi networks rely on secure certificates, obtain the certificates and store them in the device's secure credential storage, before configuring access to the VPN or Wi-Fi networks.

If downloading the certificates from a web site, set a password for the credential storage. The device supports X.509 certificates saved in PKCS#12 key store files with a .p12 extension (if key store has a .pfx or other extension, change to .p12).

The device also installs any accompanying private key or certificate authority certificates contained in the key store.

Installing a Secure Certificate

To install a secure certificate:

1. Copy the certificate from the host computer to the root of the device's internal memory. See USB Communication for information about connecting the device to a host computer and copying files.
2. Go to **Settings**.
3. Touch **Security > Advanced > Encryption & credentials**.
4. Touch **Install from storage**.
5. Navigate to the location of the certificate file.
6. Touch the filename of the certificate to install.
7. If prompted, enter the password for credential storage. If a password has not been set for the credential storage, enter a password for it twice and then touch **OK**.
8. If prompted, enter the certificate's password and touch **OK**.
9. Enter a name for the certificate and in the Credential use drop-down, select **VPN and apps** or **Wi-Fi**.

10. Touch **OK**.

The certificate can now be used when connecting to a secure network. For security, the certificate is deleted from the internal memory.

Configuring Credential Storage Settings

1. Go to **Settings**.
2. Touch **Security > Advanced > Encryption & credentials**.
 - **Trusted credentials** - Touch to display the trusted system and user credentials.
 - **User credentials** - Touch to display user credentials.
 - **Install from storage** - Touch to install a secure certificate from the internal storage.
 - **Clear credentials** - Deletes all secure certificates and related credentials.

Development Tools

Development tools for Android include Android Studio, EMDK for Android, and StageNow.

Android Application Development

Development Workstation

Android development tools are available at developer.android.com.

To start developing applications for the device, download Android Studio. Development can take place on a Microsoft® Windows®, Mac® OS X®, or Linux® operating system.

Applications are written in Java or Kotlin, but compiled and executed in the Dalvik virtual machine. Once the Java code is compiled cleanly, the developer tools make sure the application is packaged properly, including the AndroidManifest.xml file.

Android Studio contains a full featured IDE as well as SDK components required to develop Android applications.

Enabling Developer Options

The **Developer options** screen sets development related settings. By default, the Developer Options are hidden.

1. Go to **Settings**.
2. Touch **About phone**.
3. Scroll down to **Build number**.
4. Tap **Build number** seven times. The message **You are now a developer!** appears.
5. Touch the Back button.
6. Touch **System > Advanced > Developer options**.
7. Slide the **USB debugging** switch to the **ON** position.

EMDK for Android

EMDK for Android provides developers with tools to create business applications for enterprise mobile devices. It is designed for use with Google's Android Studio and includes Android class libraries such as Barcode, sample applications with source code, and the associated documentation.

EMDK for Android allows applications to take full advantage of the capabilities that Zebra devices have to offer. It embeds Profile Manager technology within Android Studio IDE, providing a GUI-based development tool designed specifically for Zebra devices. This allows fewer lines of code, resulting in reduced development time, effort, and errors.

For more information go to: techdocs.zebra.com.

StageNow

StageNow is Zebra's next-generation Android Staging Solution built on the MX platform. It allows quick and easy creation of device profiles, and can deploy to devices simply by scanning a barcode, reading a tag, or playing an audio file.

The StageNow Staging Solution includes the following components:

- The StageNow Workstation tool installs on the staging workstation (host computer) and lets the administrator easily create staging profiles for configuring device components, and perform other staging actions such as checking the condition of a target device to determine suitability for software upgrades or other activities. The StageNow Workstation stores profiles and other created content for later use.
- The StageNow Client resides on the device and provides a user interface for the staging operator to initiate staging. The operator uses one or more of the desired staging methods (print and scan a barcode, read an NFC tag or play an audio file) to deliver staging material to the device.

For more information go to: techdocs.zebra.com.

GMS Restricted

GMS Restricted mode deactivates Google Mobile Services (GMS). All GMS apps are disabled on the device and communication with Google (analytics data collection and location services) is disabled.

Use StageNow to disable or enable GMS Restricted mode. After a device is in GMS Restricted mode, enable and disable individual GMS apps and services using StageNow. To ensure GMS Restricted mode persists after an Enterprise Reset, use the Persist Manager option in StageNow. For more information on StageNow, refer to techdocs.zebra.com.

ADB USB Setup

To use the ADB, install the USB driver. This assumes that the development SDK has been installed on the host computer. Go to developer.android.com/sdk/index.html for details on setting up the development SDK.

ADB driver for Windows and Linux are available on the Zebra Support Central web site at www.zebra.com/support. Download the ADB and USB Driver Setup package. Follow the instructions with the package to install the ADB and USB drivers for Windows and Linux.

Enabling USB Debugging

By default, USB debugging is disabled.

1. Go to **Settings**.
2. Touch **About phone**.
3. Scroll down to **Build number**.
4. Tap **Build number** seven times. The message **You are now a developer!** appears.
5. Touch the Back button.
6. Touch **System > Advanced > Developer options**.
7. Slide the **USB debugging** switch to the **ON** position.
8. Touch **OK**.
9. Connect the device to the host computer using the Rugged Charge/USB Cable.
The **Allow USB debugging?** dialog box appears on the device.
10. On the device, touch **OK**.
11. On the host computer, navigate to the **platform-tools** folder.
12. Type **adb devices**.
The following displays:
List of devices attached
XXXXXXXXXXXXXXXXX device (where XXXXXXXXXXXXXXXXXXXX is the device number).



NOTE: If device number does not appear, ensure that ADB drivers are installed properly.

13. Touch the Home button.

Application Installation

After an application is developed, install the application onto the device using one of the following methods:

- USB drive, see [Installing Applications Using a USB Drive on page 109](#).
- Android Debug Bridge, see [Installing Applications Using the Android Debug Bridge on page 110](#).
- Mobile device management (MDM) platforms that have application provisioning. Refer to the MDM software documentation for details.

Installing Applications Using a USB Drive



IMPORTANT: USB Drive must have FAT32 format.

1. Plug the USB drive into the USB port on the host computer.
2. On the host computer, open a file explorer application.
3. Copy the application **.apk** file from the host computer to the USB drive.



CAUTION: Follow the host computer's instructions to eject the USB drive correctly to avoid losing information.

4. Eject the USB drive from the host computer.

5. Remove the dust cover on the back of the device. See [Figure 3 on page 17](#).
6. Plug the USB drive into the USB port on the device, see [Figure 4 on page 18](#). A notification appears indicating that the device detected the USB drive.
7. Swipe the screen up and select  to view files on the USB drive.
8. Touch **General USB drive**.
9. Locate the application .apk file.
10. Touch the application file.
11. Touch **Continue** to install the app or **Cancel** to stop the installation.
12. To confirm installation and accept what the application affects, touch **Install** otherwise touch **Cancel**.
13. Touch **Open** to open the application or **Done** to exit the installation process. The application appears in the App list.
14. Disconnect the USB drive from the host computer.

Installing Applications Using the USB Connection

1. Pull down the Notification panel and touch **Charging this device via USB**.
2. Touch **File Transfer**.
3. On the host computer, open a file manager application.
4. On the host computer, copy the application .apk file from the host computer to the device.
5. Disconnect the device from the host computer.
6. Swipe the screen up and select  to view files on the Internal Storage.
7. Locate the application .apk file.
8. Touch the application file.
9. Touch **Continue** to install the app or **Cancel** to stop the installation.
10. To confirm installation and accept what the application affects, touch **Install** otherwise touch **Cancel**.
11. Touch **Open** to open the application or **Done** to exit the installation process. The application appears in the App list.

Installing Applications Using the Android Debug Bridge

Use ADB commands to install application onto the device.



CAUTION: When connecting the device to a host computer, follow the host computer's instructions for connecting and disconnecting USB devices, to avoid damaging or corrupting files.

1. Ensure that the ADB drivers are installed on the host computer. See [ADB USB Setup on page 108](#).
2. Using a T10 Torx screwdriver, remove four screws securing the top cover to the device.

Figure 36 Remove Top Cover

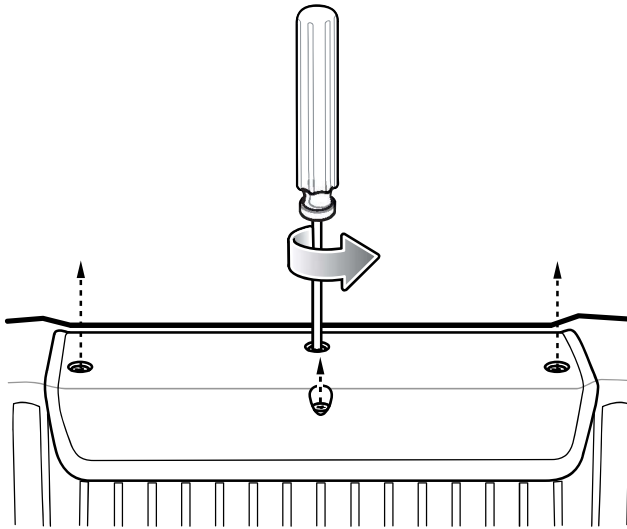

CAUTION: When the user connects a USB cable to the USB-C port on top of the device, the USB and RS-232 ports on the bottom are disabled.

3. Connect the device to a host computer using USB-C cable. See [USB Communication on page 40](#).
4. Go to **Settings**.
5. Touch **System > Advanced > Developer options**.
6. Slide the switch to the **ON** position.
7. Touch **USB Debugging**. A check appears in the check box. The **Allow USB debugging?** dialog box appears.
8. Touch **OK**.
9. On the host computer, open a command prompt window and use the adb command:
`adb install <application>`
where: <application> = the path and filename of the apk file.
10. Disconnect the device from the host computer. See [USB Communication on page 40](#).
11. Disconnect the USB-C cable from the device.
12. Replace the top cover.
13. Secure the top cover to the device using the four screws.

Figure 37 Replace Top Cover

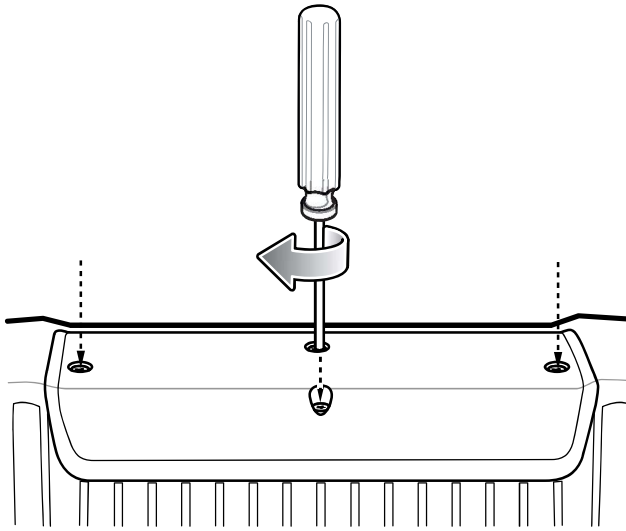

14. Torque the screws to 6kg-cm (5.2lbs-in).

Uninstalling an Application

1. Go to **Settings**.
2. Touch **Apps & notifications**.
3. Touch **See all apps** to view all apps in the list.
4. Scroll through the list to the app.
5. Touch the app. The **App info** screen appears.
6. Touch **Uninstall**.
7. Touch **OK** to confirm.

Performing a System Update

System Update packages can contain either partial or complete updates for the operating system. Zebra distributes the System Update packages on the Zebra Support & Downloads web site. Perform a system update using ADB.

Downloading the System Update Package

1. Go to the Zebra Support & Downloads web site, www.zebra.com/support.
2. Download the appropriate System Update package to a host computer.
3. Press the Up and Down arrow keys to navigate to the System Update file.

Performing a System Update Using USB Drive



WARNING: Do not remove the USB drive during system update. Damage to device can occur.

To update the system using a USB drive:



IMPORTANT: USB drive must have FAT32 format.

1. Install the USB drive into the host computer USB port.
2. Copy the System Update zip file to the root of a USB drive.
3. Properly eject the USB drive from host computer and remove the USB drive.
4. Remove the dust cover from the back of the device.
5. Insert the USB drive into the USB port.
6. Press and hold the Power button until the menu appears.
7. Touch **Restart**. The device resets.
8. Press and hold the **blue+** button until the Zebra logo screen appears. The System Recovery screen appears.
9. Press the Volume Up and Volume Down buttons to navigate to **apply upgrade from USB drive**.
10. Press the Power button.
11. Use the Volume Up and Volume Down buttons to navigate to the System Update zip file.
12. Press the Power button. The System Update installs and then the device returns to the Recovery screen.
13. Press the Power button to reboot the device.

Performing a System Update Using ADB

1. Using a T10 Torx screwdriver, remove four screws securing the top cover to the device.



IMPORTANT: When the user connects a USB cable to the USB-C port on top of the device, the USB and RS-232 ports on the bottom are disabled.

2. Connect the device to a host computer using a USB-C cable.
3. Go to **Settings**.
4. Touch **System > Advanced > Developer options**.
5. Slide the switch to the **ON** position.
6. Touch **USB Debugging**. A check appears in the check box. The **Allow USB debugging?** dialog box appears.
7. Touch **OK**.
8. On the host computer, open a command prompt window and use the adb command:

```
adb devices
```

The following displays:

```
List of devices attached
```

```
XXXXXXXXXXXXXXXXX device (where XXXXXXXXXXXXXXXXXXXX is the device number).
```



NOTE: If device number does not appear, ensure that ADB drivers are installed properly.

9. Type:
`adb reboot recovery`
10. Press Enter. The System Recovery screen appears on the device.
11. Press the Up and Down buttons to navigate to **Apply upgrade from ADB**.
12. Use the Up and Down buttons to navigate to **Full OTA Package** or **Diff OTA Package**.
13. Press the Power button.
14. On the host computer command prompt window type:
`adb sideload <file>`
where: <file> = the path and filename of the zip file.
15. Press Enter. The System Update installs (progress appears as percentage in the Command Prompt window) and then the System Recovery screen appears on the device.
16. Disconnect the USB-C cable from the device.
17. Replace the top cover.
18. Secure the top cover to the device using the four screws. See [Figure 37 on page 112](#).
19. Torque the screws to 6kg-cm (5.2lbs-in).

Verifying System Update Installation

1. Go to **Settings**.
2. Touch **About phone**.
3. Scroll down to **Build number**.
4. Ensure that the build number matches the new system update package file number.

Enterprise Reset

An Enterprise Reset erases all user data in the /data partition, including data in the primary storage locations (/sdcard and emulated storage).

Before performing an Enterprise Reset, provision all necessary configuration files and restore after the reset.

Perform Enterprise Reset using device settings, or ADB.

Perform Enterprise Reset using device settings, a USB drive, or using ADB.

Performing an Enterprise Reset From Device Settings

1. Go to **Settings**.
2. Touch **System > Reset options > Erase all data (enterprise reset)**.
3. Touch **Erase all data** twice to confirm the Enterprise Reset.

Downloading the Enterprise Reset Package

1. Go to the Zebra Support & Downloads web site, www.zebra.com/support.
2. Download the Enterprise Reset file to a host computer.

Performing an Enterprise Reset Using a USB Drive

To perform an Enterprise Reset using USB drive:

1. Copy the Enterprise Reset zip file to the root of the USB drive.
 - Copy the zip file to a USB drive using a host computer and then installing the USB drive into the device.
 - Connect the device with a USB drive already installed to the host computer and copy zip file to the USB drive. Disconnect the device from the host computer.
2. Press and hold the Power button until the menu appears.
3. Touch **Restart**. The device resets.
4. Press and hold the **blue** button until the Zebra boot screen appears. The Android Recovery screen appears.
5. Press the Up and Down buttons to navigate to the **apply update from USB drive**.
6. Press the Power button.
7. Press the Up and Down buttons to navigate to the Enterprise Reset file.
8. Press the Power button. The Enterprise Reset occurs and then the device returns to the Recovery screen.
9. Press the Power button.

Performing an Enterprise Reset Using ADB

1. Using a T10 Torx screwdriver, remove four screws securing the top cover to the device. See [Figure 36 on page 111](#).



IMPORTANT: When the user connects a USB cable to the USB-C port on top of the device, the USB and RS-232 ports on the bottom are disabled.

2. Connect the device to a host computer using a micro USB-C cable.
3. Go to **Settings**.
4. Touch **System > Advanced > Developer options**.
5. Slide the switch to the **ON** position.
6. Touch **USB Debugging**. A check appears in the check box. The **Allow USB debugging?** dialog box appears.
7. Touch **OK**.
8. On the host computer, open a command prompt window and type:

`adb devices.`

The following displays:

List of devices attached

XXXXXXXXXXXXXXXXX device (where XXXXXXXXXXXXXXXXXXXX is the device number).



NOTE: If device number does not appear, ensure that ADB drivers are installed properly.

9. Type:
`adb reboot recovery`
10. Press Enter. The System Recovery screen appears on the device.
11. Press the Up and Down buttons to navigate to **Apply upgrade from ADB**.
12. Press the Power button.
13. Press the Up and Down buttons to navigate to **Full OTA Package**.
14. Press the Power button.
15. On the host computer command prompt window type:
`adb sideload <file>`
where: <file> = the path and filename of the zip file.
16. Press Enter. The Enterprise Reset package installs and then the System Recovery screen appears on the device.
17. Press the Power button to reboot the device.
18. Disconnect the USB-C cable from the device.
19. Replace the top cover.
20. Secure the top cover to the device using the four screws. See [Figure 37 on page 112](#).
21. Torque the screws to 6kg-cm (5.2lbs-in).

Performing a Factory Reset

A Factory Reset erases all data in the `/data` and `/enterprise` partitions in internal storage and clears all device settings. A Factory Reset returns the device to the last installed operating system image. To revert to a previous operating system version, re-install that operating system image. See [Performing a System Update](#) for more information.

Downloading the Factory Reset Package

To download the Factory Reset package:

1. Go to the Zebra Support & Downloads web site, www.zebra.com/support.
2. Download the appropriate Factory Reset file to a host computer.

Performing a Factory Reset Using a USB Drive

1. Copy the Factory Reset zip file to the root of the USB drive.
 - Copy the zip file to a USB drive using a host computer and then installing the USB drive into the device.
 - Connect the device with a USB drive already installed to the host computer and copy the zip file to the USB drive. Disconnect the device from the host computer.
2. Press and hold the Power button until the menu appears.
3. Touch **Restart**. The device resets.
4. Press and hold the **blue** button until the Zebra boot screen. The System Recovery screen appears.

5. Press the Up and Down buttons to navigate to the **apply update from USB drive**.
6. Press the Power button.
7. Press the Up and Down buttons to navigate to the Android Reset file.
8. Press the Power button. The Factory Reset occurs and then the device returns to the Recovery screen.
9. Press the Power button.

Performing a Factory Reset Using ADB

To perform an Factory Reset using ADB:

1. Using a T10 Torx screwdriver, remove four screws securing the top cover to the device. See [Figure 36 on page 111](#).



IMPORTANT: When the user connects a USB cable to the USB-C port on top of the device, the USB and RS-232 ports on the bottom are disabled.

2. Connect the device to a host computer using a USB-C cable.
3. Go to **Settings**.
4. Touch **System > Advanced > Developer options**.
5. Slide the switch to the **ON** position.
6. Touch **USB Debugging**. A check appears in the check box. The **Allow USB debugging?** dialog box appears.
7. Touch **OK**.
8. On the host computer, open a command prompt window and type:

```
adb devices.
```

The following displays:

```
List of devices attached
```

```
XXXXXXXXXXXXXXXXX device (where XXXXXXXXXXXXXXXXXXXX is the device number).
```



NOTE: If device number does not appear, ensure that ADB drivers are installed properly.

9. Type:

```
adb reboot recovery
```
10. Press Enter. The System Recovery screen appears on the device.
11. Press the Up and Down buttons to navigate to **Apply upgrade from ADB**.
12. Press the Power button.
13. Press the Up and Down buttons to navigate to **Full OTA Package**.
14. Press the Power button.
15. On the host computer command prompt window type:

```
adb sideload <file>
```

where: <file> = the path and filename of the zip file.
16. Press Enter. The Factory Reset package installs and then the System Recovery screen appears on the device.

17. Press the Power button to reboot the device.
18. Disconnect the USB-C cable from the device.
19. Replace the top cover.
20. Secure the top cover to the device using the four screws. See [Figure 37 on page 112](#).
21. Torque the screws to 6 kg-cm (5.2 lbs-in).

Storage

The device contains the following types of file storage:

- Random Access Memory (RAM)
- Internal storage
- External storage
- Enterprise folder.

Random Access Memory

Executing programs use RAM to store data. Data stored in RAM is lost upon a reset. The operating system manages how applications use RAM. It only allows applications and component processes and services to use RAM when required. It may cache recently used processes in RAM, so they restart more quickly when opened again, but it will erase the cache if it needs the RAM for new activities.

The screen displays the amount of used and free RAM.

- **Performance** - Indicates memory performance.
- **Total memory** - Indicates the total amount of RAM available.
- **Average used (%)** - Indicates the average amount of memory (as a percentage) used during the period of time selected (default - 3 hours).
- **Free** - Indicates the total amount of unused RAM.
- **Memory used by apps** - Touch to view RAM usage by individual apps.

Viewing Memory

1. Go to **Settings**.
2. Touch **System > Advanced > Developer options > Memory**.

Internal Storage

The device has internal storage. The internal storage content can be viewed and files copied to and from when the device is connected to a host computer. Some applications are designed to be stored on the internal storage rather than in internal memory.

Viewing Internal Storage

1. Go to **Settings**.
 2. Touch **Storage**.
- **Internal Storage** - Displays the total amount of space on internal storage and amount used.

If the device has removable storage installed, touch **Internal shared storage** to display a the amount of internal storage used by apps, photos, videos, audio and other files.

External Storage

The device can have a removable USB drive. The USB drive content can be viewed and files copied to and from when the device is connected to a host computer.

Viewing External Storage

1. Go to **Settings**.
2. Touch **Storage**.

Portable storage displays the total amount of space on the installed USB drive and the amount used.

To unmount the USB drive, touch .

Touch **General USB Drive** to view the contents of the card.

Formatting a USB Drive as Portable Storage

1. Touch **USB drive**.
2. Touch  > **Storage settings**.
3. Touch **Format**.
4. Touch **ERASE & FORMAT**.
5. Touch **DONE**.

Enterprise Folder

The Enterprise folder (within internal flash) is a super-persistent storage that is persistent after a reset and an Enterprise Reset. The Enterprise folder is erased during a Factory Reset. The Enterprise folder is used for deployment and device-unique data. The Enterprise folder is approximately 128 MB (formatted). Applications can persist data after an Enterprise Reset by saving data to the enterprise/user folder. The folder is ext4 formatted and is only accessible from a host computer using ADB or from an MDM.

Managing Apps

Apps use two kinds of memory: storage memory and RAM. Apps use storage memory for themselves and any files, settings, and other data they use. They also use RAM when they are running.

1. Go to **Settings**.
2. Touch **Apps & notifications**.
3. Touch **See all XX apps** to view all apps on the device.
4. Touch  > **Show system** to include system processes in the list.
5. Touch an app, process, or service in the list to open a screen with details about it and, depending on the item, to change its settings, permissions, notifications and to force stop or uninstall it.



App Details

Apps have different kinds of information and controls.

- **Force stop** - Stop an app.
- **Disable** - Disable an app.
- **Uninstall** - Remove the app and all of its data and settings from the device. See Uninstalling an Application for information about uninstalling apps.
- **Notifications** - Set the app notification settings.
- **Permissions** - Lists the areas on the device that the app has access to.
- **Storage & cache** - Lists how much information is stored, and includes buttons for clearing it.
- **Mobile data & Wi-Fi** - Provides information about data consumed by an app.
- **Advanced**
 - Screen time - Displays the amount of time the app has displayed on the screen.
 - **Battery** - Lists the amount of computing power used by the app.
 - **Open by default** - If you have configured an app to launch certain file types by default, you can clear that setting here.
 - **Display over other apps** - allows an app to display on top of other apps.
 - **App details** - Provides a link to additional app details on the Play store.
 - **Additional settings in the app** - Opens settings in the app.
 - **Modify system settings** - Allows an app to modify the system settings.

Managing Downloads

Files and apps downloaded using the Browser or Email are stored on the USB drive or Internal storage in the Download directory. Use the Downloads app to view, open, or delete downloaded items.

1. Swipe the screen up and touch .
2. Touch  > **Downloads**.
3. Touch and hold an item, select items to delete and touch . The item is deleted from the device.

Maintenance and Troubleshooting

Introduction

This chapter includes instructions on cleaning the device and provides troubleshooting solutions for potential problems during device operations.



WARNING: Danger due to electric shock when cleaning and maintaining the device. To avoid electric shock, turn the device off and disconnect it from the power supply before cleaning or maintaining it.

Cleaning



CAUTION: Do not use compressed air, a high-pressure cleaner or vacuum cleaner, as this can damage the surface. Using a high-pressure cleaner poses the additional risk of water entering the device and damaging the electronics or display.

Housing Cleaning

Clean the fully assembled device vehicle mount computer housing using only a mild detergent on a lightly dampened soft cloth.

Touchscreen Cleaning

Use neutral detergent or isopropyl alcohol on a clean soft cloth to clean the panel surface. Do not use any kind of chemical solvent, acidic or alkali solution.

Touchscreen

The device is equipped with a capacitive touchscreen.



CAUTION: Keep the touchscreen clean (see [Touchscreen Cleaning on page 121](#)).

Do not apply adhesives to the surface.

Avoid high voltage and/or static charge.

Do not use ball point pens, writing utensils, tools, or sharp objects.

Touch the panel only with your finger to ensure normal operation.

Operate in a stable environment. Abrupt variation of temperature and humidity may cause malfunction.

Avoid applying excessive activation force or sudden impact on the touchscreen surface.

Operation of the capacitive touch screen is recommended with:

- Clean, dry fingers.
- Clean, dry, soft gloves.

Troubleshooting

Resetting the Device

There are four reset functions:

- Soft reset
- Hard reset
- Enterprise reset. See [Enterprise Reset on page 106](#).
- Factory reset. See [Performing a Factory Reset on page 108](#).

Performing a Soft Reset

Perform a soft reset if applications stop responding.

1. Press and hold the Power button until the menu appears.
2. Touch **Restart**.
3. The device reboots.

Performing a Hard Reset



CAUTION: Performing a hard reset with a USB drive installed in the device may cause damage or data corruption to the USB drive.

Perform a hard reset if the device stops responding.

1. Press and hold the Power button for at least 16 seconds.
2. Release the Power button when the Zebra logo appears.
3. The device reboots.

VC8300

Table 14 Troubleshooting

Symptom	Possible Cause	Solution
The vehicle computer does not power on or shuts off suddenly.	The power cable ignition sense wire (yellow) is not connected properly.	Verify that the power cable is connected properly. See Wiring Vehicle Power to the VC8300 on page 25 .
	Power cable not connected properly or unplugged.	Connect power cable to power cable portion underside of vehicle computer. Turn the main power switch on.
	If the vehicle computer is powered by a vehicle battery, the vehicle battery is depleted.	Replace or charge the vehicle battery.
Cannot see characters on display.	Vehicle computer not powered on (Power LED is Off).	Press the Power button on.
	Screen is too dark.	Adjust the brightness; see Figure 1 on page 16 .
	The vehicle computer is in suspend mode (Power LED is on).	Press the Power button to turn on the vehicle computer.
The touchscreen is not working.	Replacement screen protector was damaged.	Replace screen protector.
	Touch screen is damaged.	See system administrator.

Table 14 Troubleshooting (Continued)

Symptom	Possible Cause	Solution
The optional serial scanner does not operate.	Scanner is not properly connected to the vehicle computer.	Connect the scanner to the COM1 or COM2 port. Ensure the proper COM port is selected in the VC Settings application, see Connecting an RS-232 Scanner on page 63 . If the problem continues, refer to the scanner Product Reference Guide.
	External power is not connected.	Verify external power connection.
	Power is not applied to COM port.	Enable power to COM ports. See VC Settings on page 56 .
	Serial COM port in not enabled in DataWedge.	Enable the serial COM port in the DataWedge profile.
	USB cable is connected to USB port on top of device.	Disconnect USB cable from top of device.
The optional USB scanner does not operate.	USB cable is connected to USB port on top of device.	Disconnect USB cable from top of device.
	Scanner not configured for correct protocol (SSI or HID)	Configure scanner to correct protocol. See Data Capture on page 57 .
	USB connector not connected properly.	Remove USB cable and re-connect.
No sound is heard when you tap the touchscreen or press a key.	Volume is turned down.	Adjust the volume; see Figure 1 on page 16 .
	Application currently running disabled the sound.	Configure the application to enable the sound.
	Faulty speaker.	Contact Zebra support at www.zebra.com/support .
	The optional M1000 speakerphone/mic is connected to the device.	Normal operation, sound is through speaker / mic.
Missing pixels on the display.	Faulty LCD.	Contact Zebra support. See www.zebra.com/support .
COM1 or COM2 port is not working.	Another application, or DataWedge is using the port.	Stop the application using the port or change the DataWedge COM Port Settings.
	USB cable connected to the USB port on top of the device.	Disconnect USB cable from USB port on top of the device.

Table 14 Troubleshooting (Continued)

Symptom	Possible Cause	Solution
No keys are working on the built-in keyboard.	The application does not require keyboard input.	Configure the application to use the keyboard.
	Vehicle computer is not responding.	Warm boot the vehicle computer.
The vehicle computer cannot find any Bluetooth devices nearby.	Too far from other Bluetooth devices.	Move closer to the other Bluetooth device(s).
	The Bluetooth device(s) nearby are not turned on.	Turn on the Bluetooth device(s).
	The Bluetooth device(s) are not in discoverable mode.	Set the Bluetooth device(s) to discoverable mode. If needed, refer to the device's user documentation for help.
When installed on some electric forklifts, the scanner range is shorter than it is when installed on other forklifts.	Electro-magnetic interference caused by the forklift.	Consult forklift vendor about reducing the interference by adding a capacitor between the forklift chassis and its battery's negative terminal, or another recommended solution.
Wi-Fi Signal strength degraded.	Incorrect antenna selection.	Check antenna selection. See VC Settings on page 56 .
	Damaged external antenna.	Either right or left external antenna broken or not connected properly.
	Using wrong antenna.	See accessory list for correct antenna for device.
Cannot find Bluetooth devices.	Incorrect antenna selection.	Check antenna selection. See VC Settings on page 56 .
	Damaged external antenna.	Right external antenna broken or not connected properly.
	Using wrong antenna.	See accessory list for correct antenna for device.

Specifications

For device technical specifications, go to zebra.com/support.

Drill Hole Dimensions

Figure 38 Drill Hole Dimensions

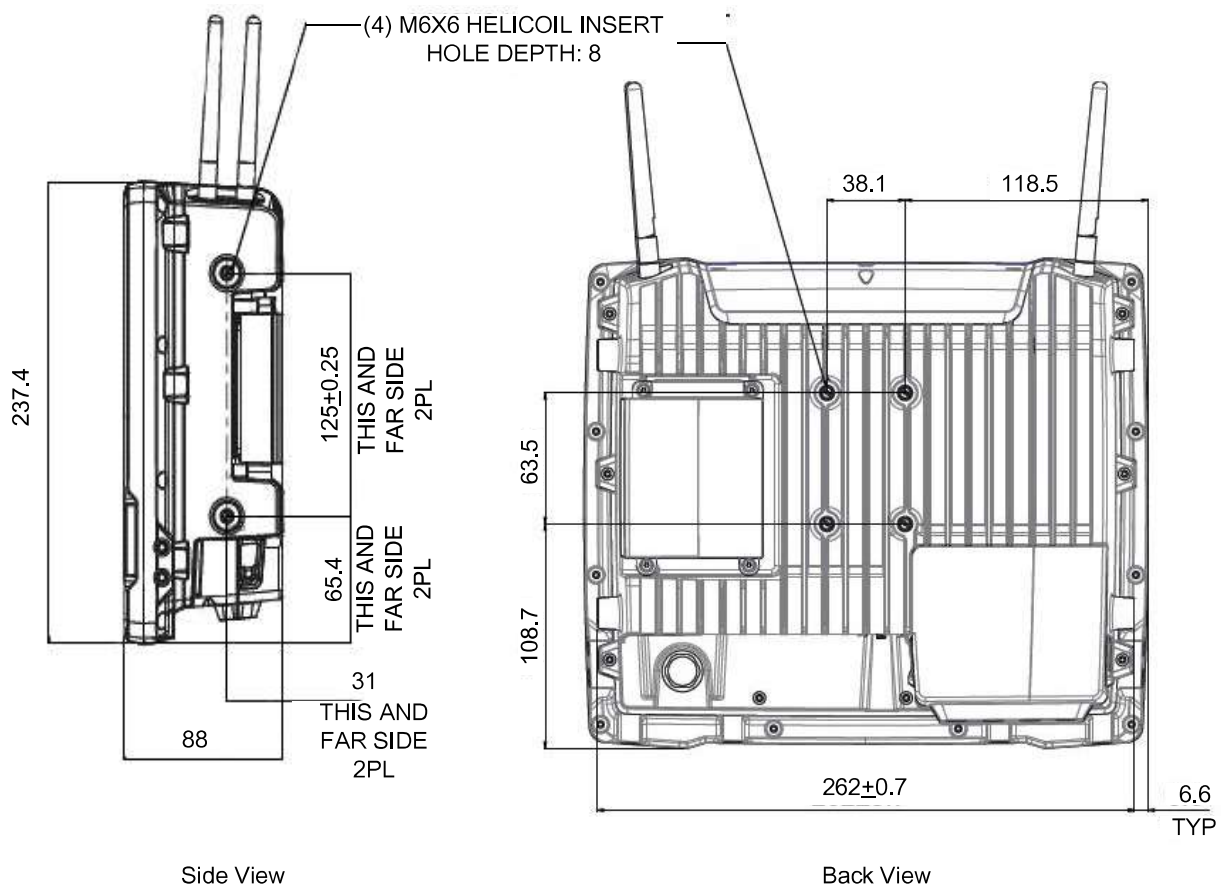

Index

A

adaptive frequency hopping	80
ambient display setting	96
apps	
accessing	45
datawedge demonstration	47
PTT Express	50
RxLogger	53
RxLogger Utility	54
VC Settings	55
Velocity	56

B

battery	
low battery notification	39
management	39
monitor usage	39
battery management	39
battery level	39
battery present status	39
bluetooth	73, 79
change name	82
PIN	80
power states	81
profiles	80
security	80

C

cable dust cover	26
cables, installing in vehicle	24
cast	83
change bluetooth name	82
cleaning	
housing	121
conventions	
notational	12

D

data capture	58
datawedge	69, 70
decoders	70
disabling	70
enable	70
datawedge demonstration	47
decoders	70
disconnect host computer	40
display settings	95

E

EAP	73
electrical installation	23
emergency shutdown	15
external antenna	26

F

file transfer	40
font size	96
Forklift	28
forklift battery replacement	28
forklift installation	23, 24
front keys	19

G

general sound setting	98
ground bolt	24

H

hard reset	122
Heater Control	
battery port heater	49
serial port heater	49
temperatures	49
USB port heater	49
Heater Status	22
home screen	33
rotation	34

Index

I

imager scanning	58
information, service	13
installation	
non-vehicle	30
vehicle	30

K

keyboard	84
keyboards	99
additional character tab	101
alpha tab	101
configuration	99
editing text	100
numeric tab	100

L

LAN	22
LED indicators	19
lock screen notifications	105
low battery notification	39

M

managing notifications	37
message URL http	
//techdocs.zebra.com/datawedge/	70
monitor battery usage	39
mounting	
assembly steps	26
instructions	23
MT43XX RAM Mount kit	88

N

near field communication	73
notification icons	35
notifications	
lock screen	105
managing	37

O

operating	
emergency	15
optional mount kits	88

P

photo transfer	40
picklist	58
power	
power down device	22
power up device	22
supply	15
protection	15
safety	15
PTT Express	
audible indicators	50
disabling communication	52
enabling communication	51
group calls	52
notification icons	51
private response	52
talk groups	52
Voice Client	50
PTT-Express	
PTT communication	52

Q

quick access panel	37
quick settings	
edit icons	38

R

RAM Mount kit	88
related documents	13
remove wi-fi	74
reseting the device	122
RS507 scanning	61
RS507/RS507x scanning	60, 63
RS6000 scanning	59
RxLogger	53
configuration	53
configuration file	53
disable logging	53
enable logging	53
extract log files	53
RxLogger Utility	54

S

scanning	58
screen blanking	55
screen font size	96
security	73
settings	95
accessing	95
ambient display	96
display	95
general sound	98
soft reset	122
software version	12
software versions	11
specifications	12
status bar	34
strain relief rail	27

T

touchscreen	121
cleaning	121
operation	121
specifications	121
transferring files using USB	40
troubleshooting	122

U

unpacking	14
USB	40

V

VC Settings	55
built-in speaker	55
display	55
ignition detection	55
peripheral power	55
screen blanking	55
WIFI antenna switching	55
VC8300	
features	16
vehicle	
battery, charging	15
vehicle-mount installation	
cables	24
Velocity	56

W

WEP	73
Wi-Fi direct	79
wireless local area network	73
WLAN	22, 73
WPA	73



BSR idware GmbH

Jakob-Haringer-Str.3

A-5020 Salzburg

<https://www.bsr.at>

sales@bsr.at